



FORD PERFORMANCE

M-2300-WR Focus ST Performance RS Rear Brake Kit

NO PART OF THIS DOCUMENT MAY BE REPRODUCED WITHOUT PRIOR AGREEMENT AND WRITTEN PERMISSION OF FORD PERFORMANCE PARTS

Please visit www.performanceparts.ford.com for the most current instruction and warranty information.

PLEASE READ ALL OF THE FOLLOWING INSTRUCTIONS CAREFULLY PRIOR TO INSTALLATION. AT ANY TIME YOU DO NOT UNDERSTAND THE INSTRUCTIONS, PLEASE CALL THE FORD PERFORMANCE TECHLINE AT 1-800-367-3788

General Service Warnings

Review carefully the information below before beginning any repair. Following these warnings is a list of specific system warnings that must be reviewed before beginning work on any listed system.

 **WARNING:** Vehicles with scheduled remote start technology may start at any time. Make sure the scheduled remote start system is disabled when servicing or working in close proximity to rotating engine parts. Failure to follow this instruction may result in serious personal injury.

 **WARNING:** Wear eye and ear protection when servicing a vehicle. Failure to follow this instruction may result in serious personal injury.

 **WARNING:** Wear protective gloves when handling components or parts that have pointed or sharp edges. Failure to follow this instruction may result in serious personal injury.

 **WARNING:** Chemicals or materials specified in this manual, if used improperly, may present a personal health hazard. Always consult the material safety information sheet before using any material specified by this manual. Failure to follow this instruction may result in serious personal injury.

 **WARNING:** Do not work under the hood of a vehicle with a damaged cooling fan, as it can separate during operation. With the ignition OFF, inspect all cooling fans for damage, cracks or separation and replace with a new fan as necessary. Failure to follow this instruction may result in serious personal injury.

 **WARNING:** Cooling fans may run with the ignition off. Disable the fans before working nearby. On electric vehicles, disconnect the charging cable to prevent unexpected fan operation. Failure to follow this instruction may result in personal injury.

 **WARNING:** Vehicles with engine auto start-stop technology may start automatically with the ignition on. Make sure the ignition is off when servicing or working in close proximity to rotating engine parts. Failure to follow this instruction may result in serious personal injury.

 **WARNING:** Serious injury may occur if the engine is accidentally started by another person during service work. Remove the key from the vehicle to prevent unauthorized starts. Failure to follow this instruction may result in serious personal injury.

Factory Ford shop manuals are available from Helm Publications, 1-800-782-4356



FORD PERFORMANCE

M-2300-WR Focus ST Performance RS Rear Brake Kit

NO PART OF THIS DOCUMENT MAY BE REPRODUCED WITHOUT PRIOR AGREEMENT AND WRITTEN PERMISSION OF FORD PERFORMANCE PARTS

⚠ WARNING: Before lifting the vehicle with a jack, make sure the jack capacity is adequate for the vehicle weight, including any vehicle cargo or modifications. Identify the correct jacking points in section 100-02 of this manual. Position the vehicle on a hard, level surface. After jacking, always support vehicle with jack stands. Never get under a vehicle supported only by a jack. Set the parking brake and block all wheels remaining on the ground. Failure to follow these instructions may result in unintended vehicle movement and serious personal injury or death.

⚠ WARNING: Before raising the vehicle on a hoist, make sure the hoist capacity is adequate for the vehicle weight, including any vehicle cargo or modifications. Always position the hoist lift arms as shown in section 100-02 of this manual. Do not use the engine to power the drive wheels unless all drive wheels are elevated off the ground. Incorrect hoist arm positioning or drive wheels in contact with the ground can cause unintended vehicle movement. Failure to follow these instructions may result in serious personal injury or death.

⚠ WARNING: Removal of heavy components (such as engines, transmissions or axles) while the vehicle is lifted on a hoist may create a dangerous weight imbalance. Restrain the vehicle on the hoist with chains or straps to prevent vehicle movement. Failure to follow this instruction may result in serious personal injury or death.

⚠ WARNING: Always secure transmission, transfer case, and axle assemblies to their service jack. Avoid obstructions while lowering and raising the jack. Improperly secured assemblies or contact with obstructions may cause the assembly to fall off the jack, which could result in serious personal injury.

⚠ WARNING: Always secure engines, transmissions, or other heavy components to the support fixture with straps and wooden support blocks. Improperly secured assemblies could fall off the fixture, resulting in serious personal injury.

⚠ WARNING: Never support an engine by the intake or exhaust manifolds. The engine may drop suddenly. Failure to follow this instruction may result in serious personal injury.

⚠ WARNING: Turn off (disable) the power running boards (if equipped) before jacking, lifting or placing any object under the vehicle. Never place your hand between the power running board and the vehicle. Extended power running boards will retract when doors are closed. Failure to follow these instructions may result in serious personal injury.

⚠ WARNING: Keep solvents away from ignition sources. Solvents may be flammable and can ignite or explode if not handled correctly. Failure to follow this instruction may result in serious personal injury.

⚠ WARNING: Use tools, not fingers, to hold flagnuts. Flagnuts may slip or spin unexpectedly when removing fasteners. Failure to follow this instruction may result in injured fingers.

Factory Ford shop manuals are available from Helm Publications, 1-800-782-4356



FORD PERFORMANCE

M-2300-WR Focus ST Performance RS Rear Brake Kit

NO PART OF THIS DOCUMENT MAY BE REPRODUCED WITHOUT PRIOR AGREEMENT AND WRITTEN PERMISSION OF FORD PERFORMANCE PARTS

Kit contains:

- 2-Rear brake hose
- 2-Rear rotor
- 1-RH Focus RS brake caliper
- 1-LH Focus RS brake caliper
- 2-Brake line screw
- 2-Brake line retaining clip
- 4-Caliper bolt

Remove the wheel and tire.

1. Disconnect the brake tube fitting.
2. Remove the clip and detach the brake hose from the bracket.

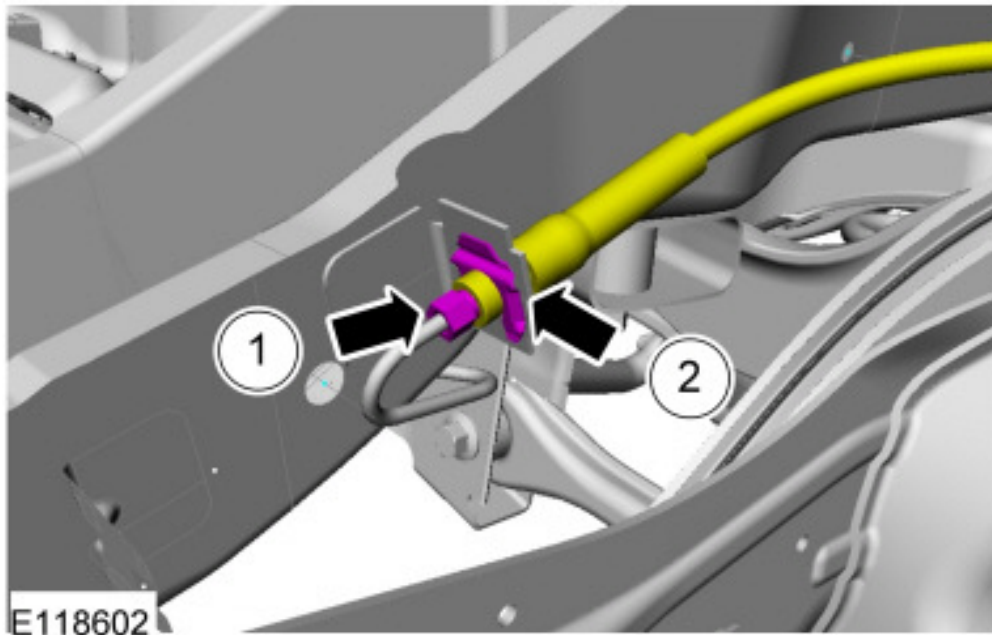

Factory Ford shop manuals are available from Helm Publications, 1-800-782-4356



FORD PERFORMANCE

M-2300-WR Focus ST Performance RS Rear Brake Kit

NO PART OF THIS DOCUMENT MAY BE REPRODUCED WITHOUT PRIOR AGREEMENT AND WRITTEN PERMISSION OF FORD PERFORMANCE PARTS

1. Remove the bolt.
2. Disconnect the brake hose fitting and remove the brake flexible hose.

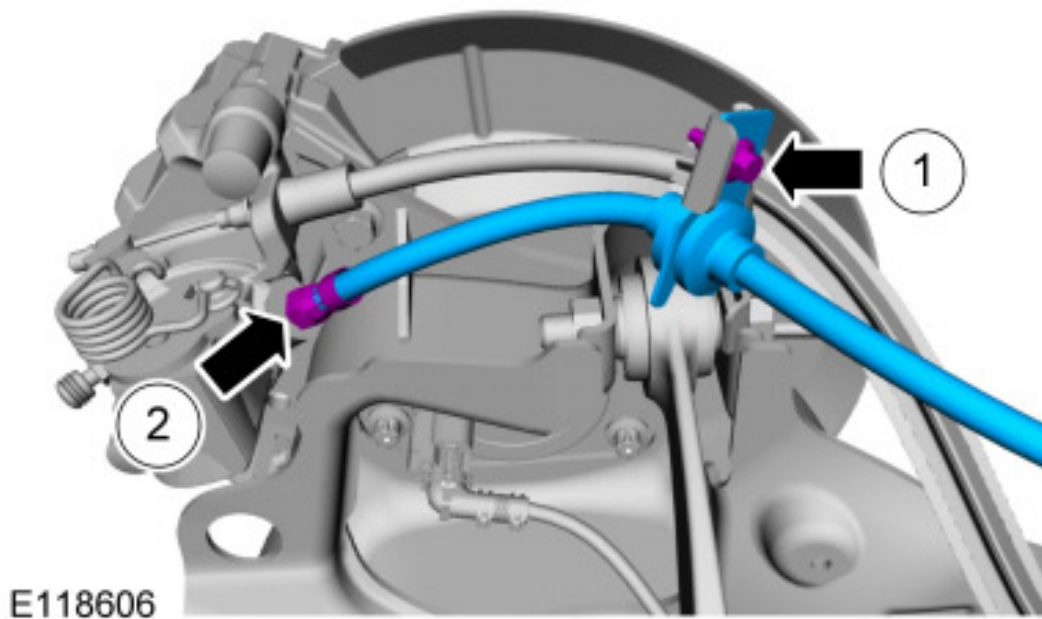

E118606

Factory Ford shop manuals are available from Helm Publications, 1-800-782-4356



FORD PERFORMANCE

M-2300-WR Focus ST Performance RS Rear Brake Kit

NO PART OF THIS DOCUMENT MAY BE REPRODUCED WITHOUT PRIOR AGREEMENT AND WRITTEN PERMISSION OF FORD PERFORMANCE PARTS

1. Rotate the brake caliper lever.
2. Detach the parking brake cable from the brake caliper lever.
3. Detach the parking brake cable from the brake caliper bracket.

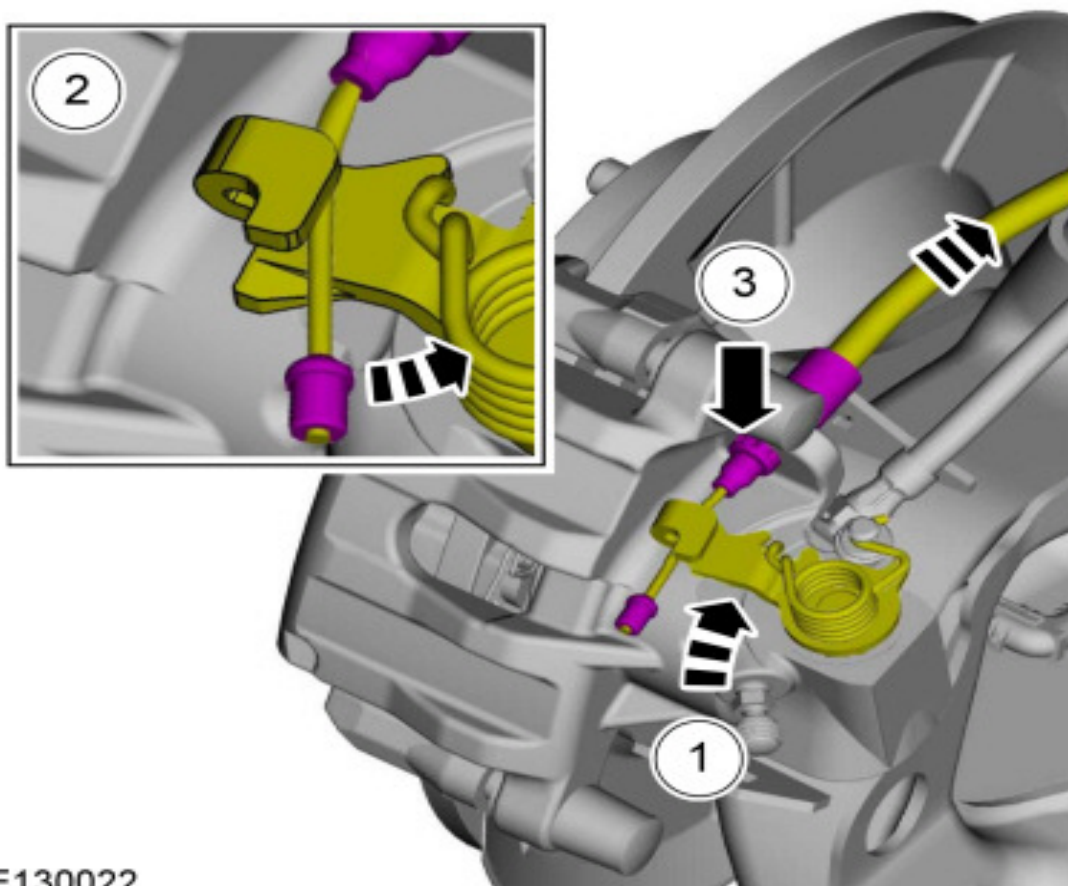

E130022

Factory Ford shop manuals are available from Helm Publications, 1-800-782-4356



FORD PERFORMANCE

M-2300-WR Focus ST Performance RS Rear Brake Kit

NO PART OF THIS DOCUMENT MAY BE REPRODUCED WITHOUT PRIOR AGREEMENT AND WRITTEN PERMISSION OF FORD PERFORMANCE PARTS

1. Remove the caps.
2. Remove the brake caliper guide pin bolts.
3. Remove caliper.

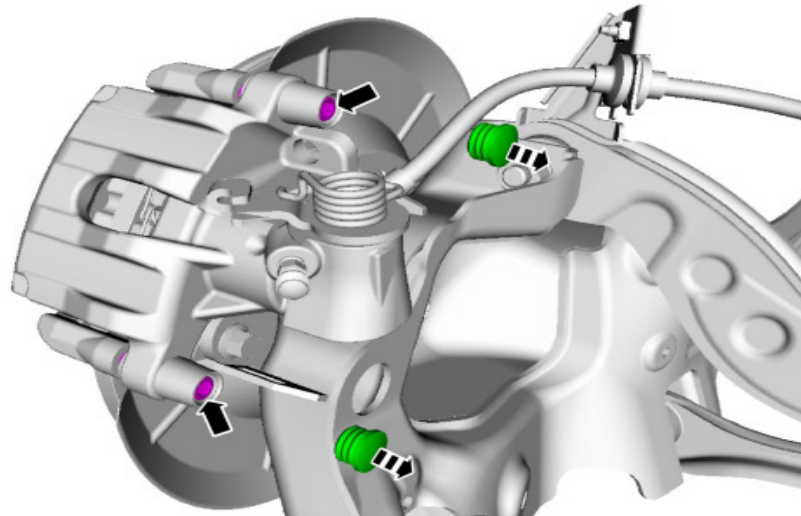

E143459

4. Remove the brake pads.

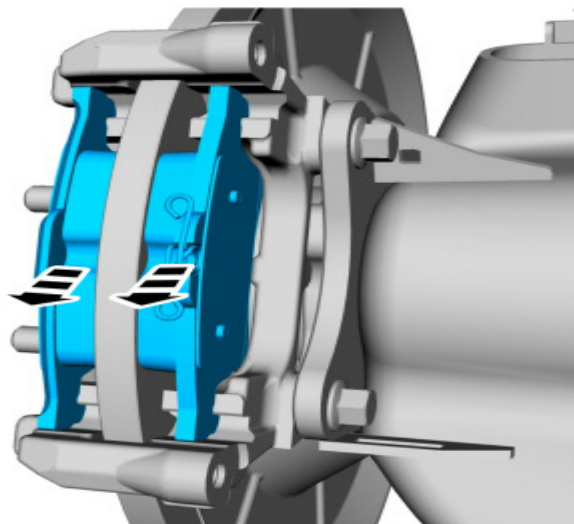

E118599

Factory Ford shop manuals are available from Helm Publications, 1-800-782-4356



FORD PERFORMANCE

M-2300-WR Focus ST Performance RS Rear Brake Kit

NO PART OF THIS DOCUMENT MAY BE REPRODUCED WITHOUT PRIOR AGREEMENT AND WRITTEN PERMISSION OF FORD PERFORMANCE PARTS

5. Remove the bolts and the brake caliper anchor plate.

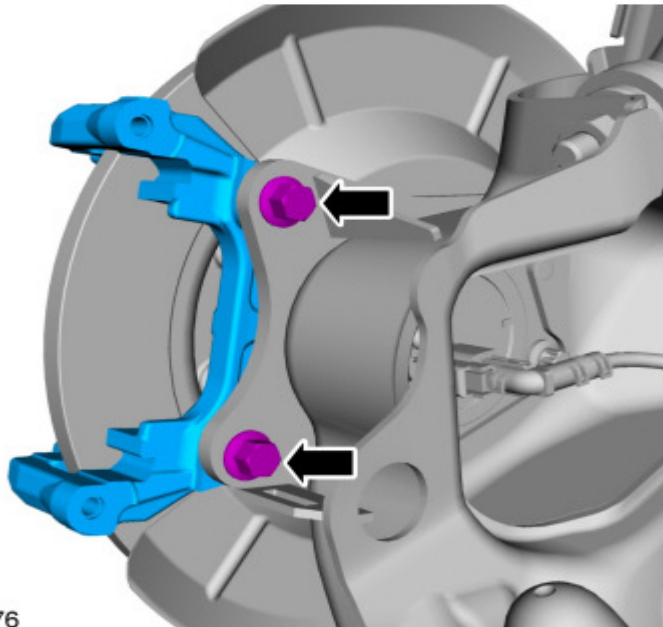

E131476

6. Remove the brake rotor.

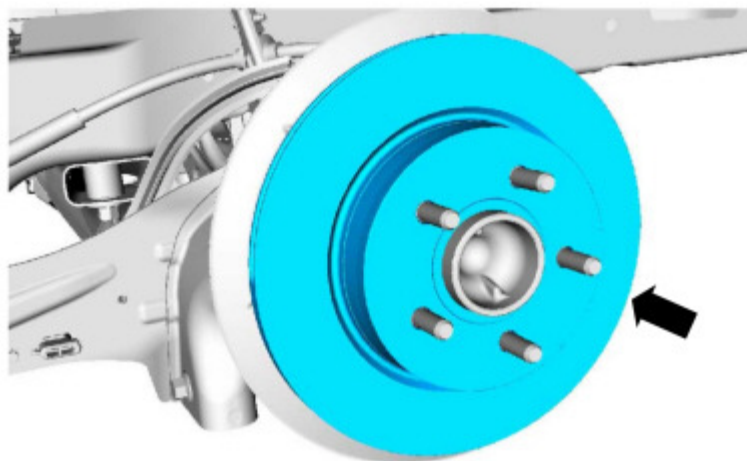

E144528

Factory Ford shop manuals are available from Helm Publications, 1-800-782-4356



FORD PERFORMANCE

M-2300-WR Focus ST Performance RS Rear Brake Kit

NO PART OF THIS DOCUMENT MAY BE REPRODUCED WITHOUT PRIOR AGREEMENT AND WRITTEN PERMISSION OF FORD PERFORMANCE PARTS

Installation

1. **NOTICE:** Make sure that the mating faces are clean and free of corrosion and foreign material.

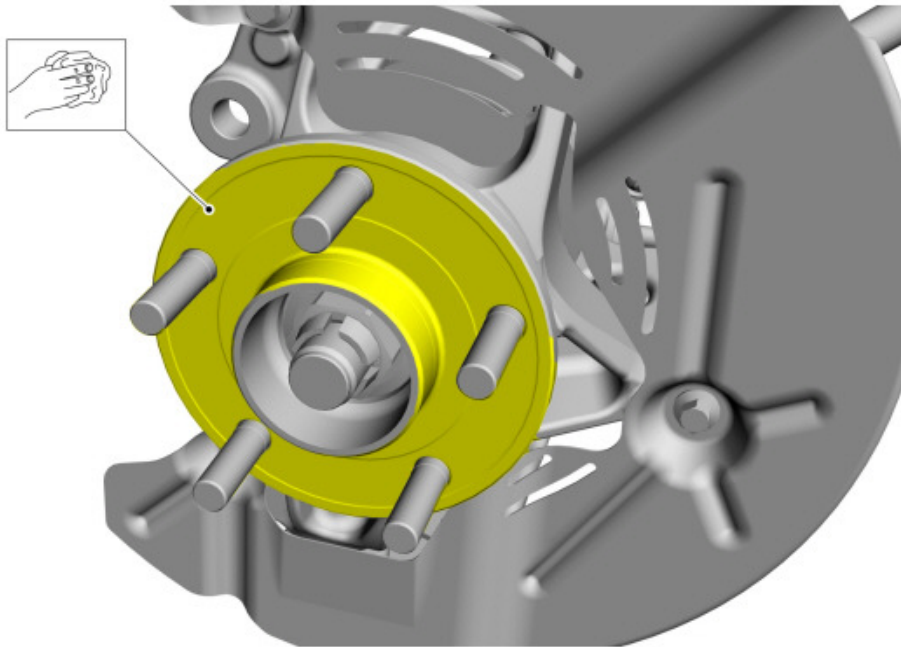

2. Install new brake rotor.

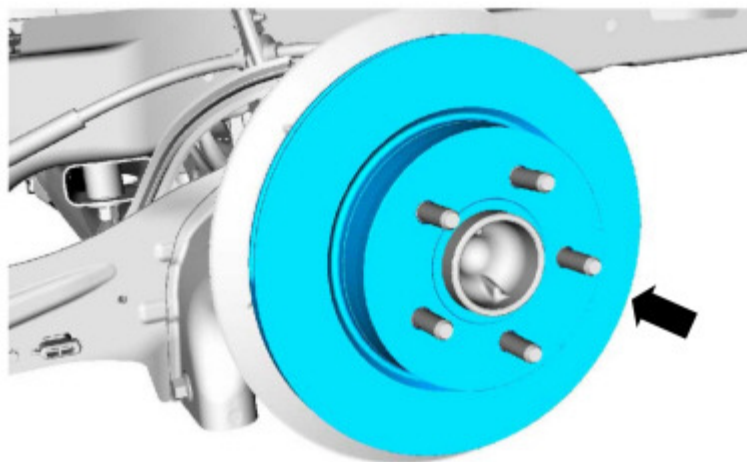

Factory Ford shop manuals are available from Helm Publications, 1-800-782-4356



FORD PERFORMANCE

M-2300-WR Focus ST Performance RS Rear Brake Kit

NO PART OF THIS DOCUMENT MAY BE REPRODUCED WITHOUT PRIOR AGREEMENT AND WRITTEN PERMISSION OF FORD PERFORMANCE PARTS

3. Install the bolts and the brake caliper anchor plate.
Torque: 52 lb.ft (70 Nm)

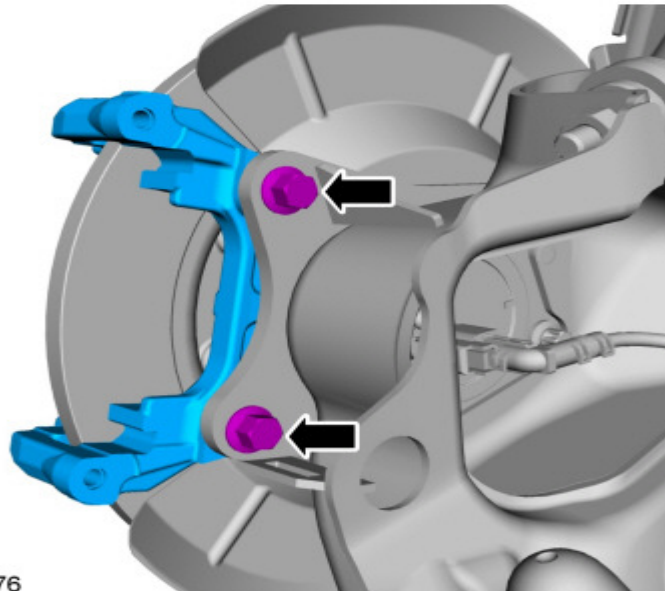

4. Install the brake pads.

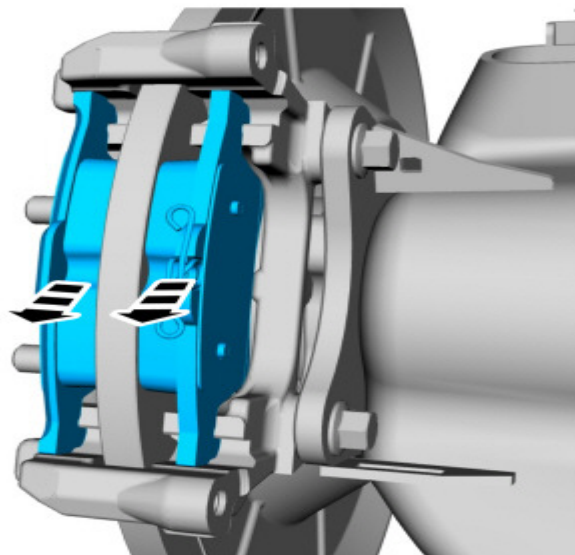

Factory Ford shop manuals are available from Helm Publications, 1-800-782-4356



FORD PERFORMANCE

M-2300-WR Focus ST Performance RS Rear Brake Kit

NO PART OF THIS DOCUMENT MAY BE REPRODUCED WITHOUT PRIOR AGREEMENT AND WRITTEN PERMISSION OF FORD PERFORMANCE PARTS

5. Install the brake caliper guide pin bolts.
Torque: 21 lb.ft (28 Nm)
6. Install the caps

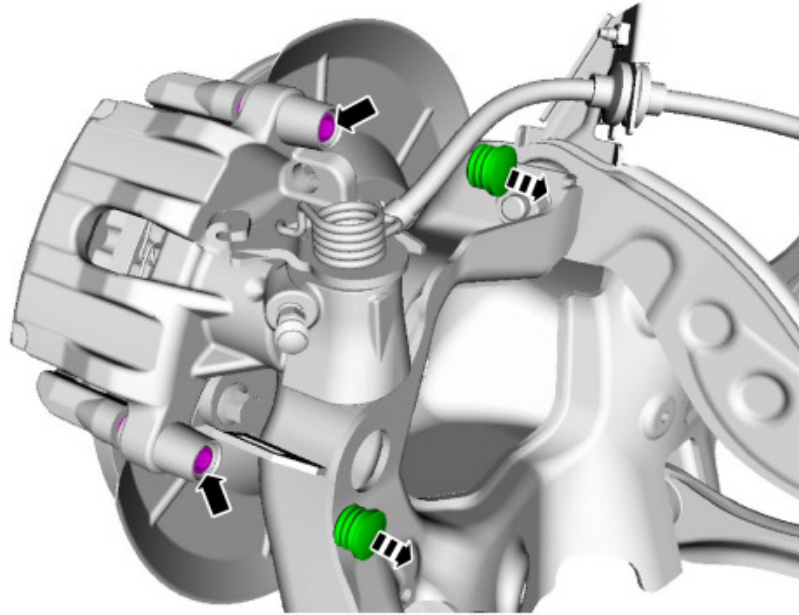

E143459

Factory Ford shop manuals are available from Helm Publications, 1-800-782-4356



FORD PERFORMANCE

M-2300-WR Focus ST Performance RS Rear Brake Kit

NO PART OF THIS DOCUMENT MAY BE REPRODUCED WITHOUT PRIOR AGREEMENT AND WRITTEN PERMISSION OF FORD PERFORMANCE PARTS

7. Attach the parking brake cable to the brake caliper bracket.
8. Attach the parking brake cable to the brake caliper lever.
9. Rotate the brake caliper lever.

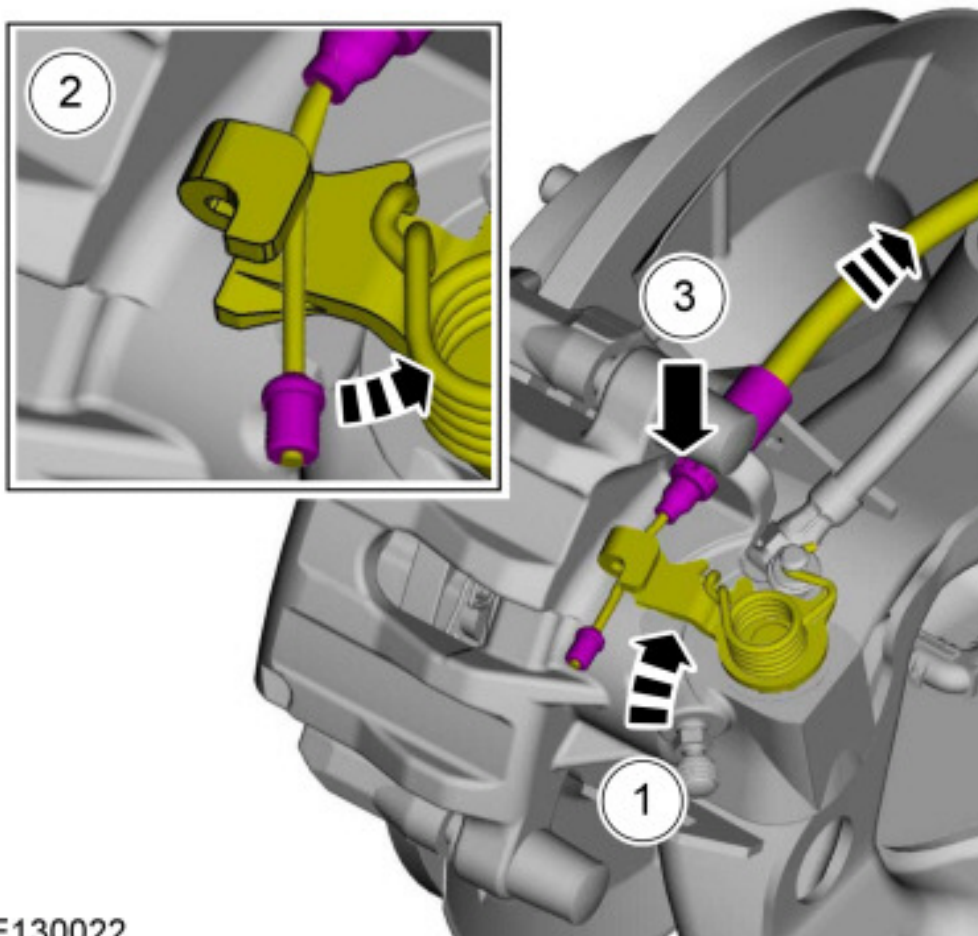

E130022

Factory Ford shop manuals are available from Helm Publications, 1-800-782-4356



FORD PERFORMANCE

M-2300-WR Focus ST Performance RS Rear Brake Kit

NO PART OF THIS DOCUMENT MAY BE REPRODUCED WITHOUT PRIOR AGREEMENT AND WRITTEN PERMISSION OF FORD PERFORMANCE PARTS

10. Install the bolt.
Torque: 22 lb.ft (30 Nm)
11. Install the brake flexible hose. Connect the brake hose fitting and
Torque: 97 lb.in (11 Nm)

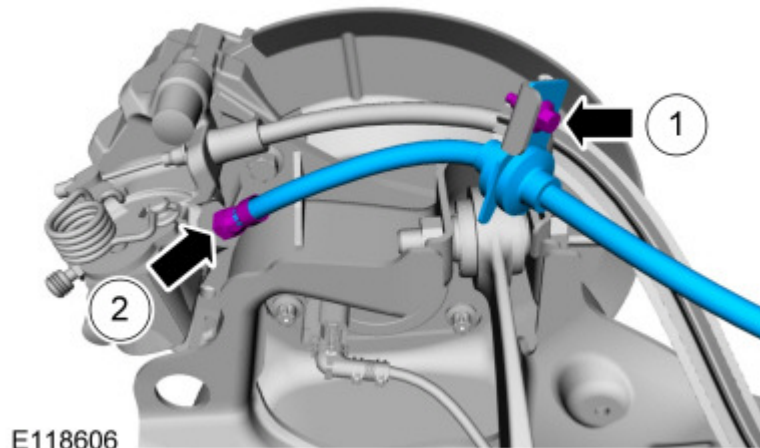

Bleed Brakes

NOTICE: If the fluid is spilled on the paintwork, the affected area must be immediately washed down with cold water.

1. **NOTE:** Make sure the area around the master cylinder cap is clean and free of foreign material.

Remove the brake fluid reservoir cap.

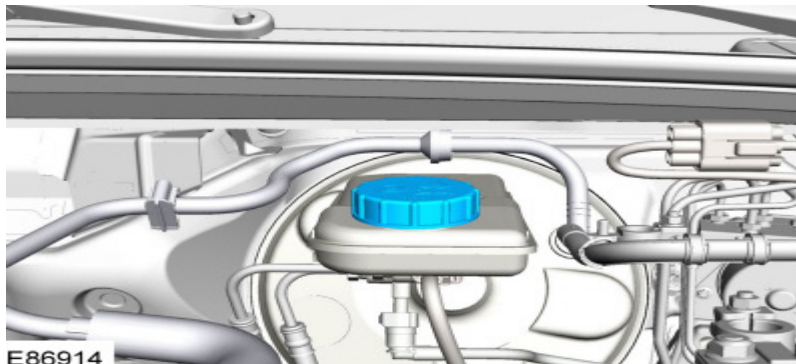

Factory Ford shop manuals are available from Helm Publications, 1-800-782-4356



FORD PERFORMANCE

M-2300-WR Focus ST Performance RS Rear Brake Kit

NO PART OF THIS DOCUMENT MAY BE REPRODUCED WITHOUT PRIOR AGREEMENT AND WRITTEN PERMISSION OF FORD PERFORMANCE PARTS

2. Make sure the fluid reservoir is filled with clean specified brake fluid.

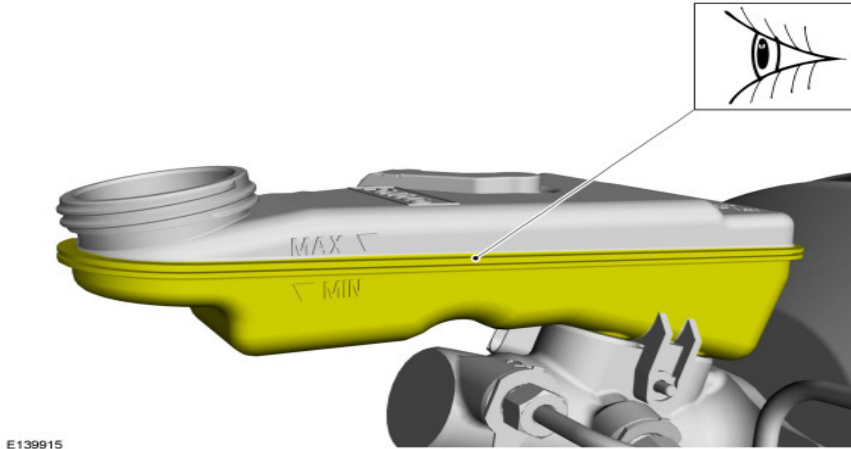

3.
 1. **NOTE:** Master cylinder pressure bleeder adapter tools are available from various manufacturers of pressure bleeding equipment. Follow the instructions of the manufacturer when installing the adapter.

Install the bleeder adapter to the brake master cylinder reservoir and attach the bleeder tank hose to the fitting on the adapter.

2. **NOTE:** Make sure the bleeder tank contains enough clean, specified brake fluid to complete the bleeding operation.

Open the valve on the bleeder tank and apply 207-345 kPa (30-50 psi) to the brake system.

Factory Ford shop manuals are available from Helm Publications, 1-800-782-4356



FORD PERFORMANCE

M-2300-WR Focus ST Performance RS Rear Brake Kit

NO PART OF THIS DOCUMENT MAY BE REPRODUCED WITHOUT PRIOR AGREEMENT AND WRITTEN PERMISSION OF FORD PERFORMANCE PARTS

3. Bleeding steps must be followed in the order indicated in the graphic.

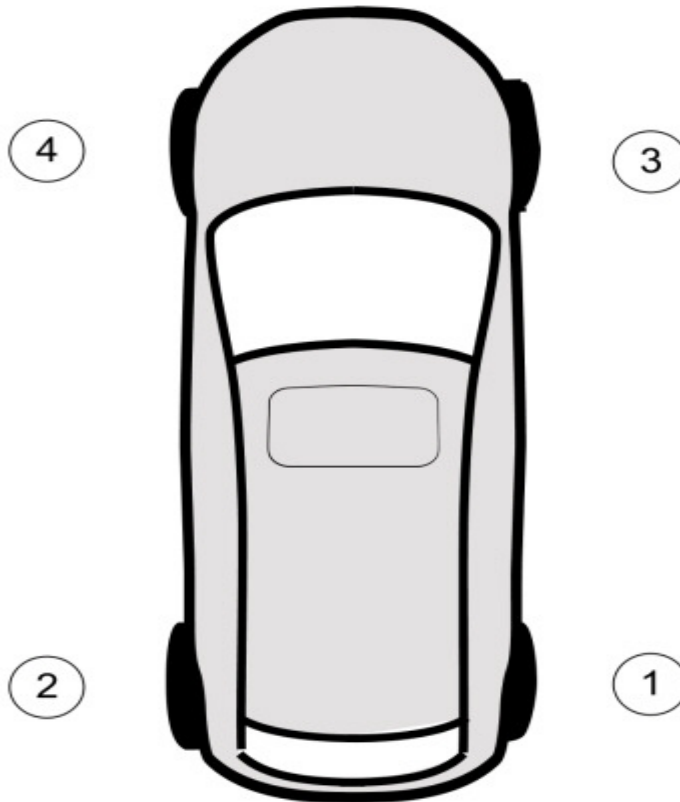

E168558

Factory Ford shop manuals are available from Helm Publications, 1-800-782-4356



FORD PERFORMANCE

M-2300-WR Focus ST Performance RS Rear Brake Kit

NO PART OF THIS DOCUMENT MAY BE REPRODUCED WITHOUT PRIOR AGREEMENT AND WRITTEN PERMISSION OF FORD PERFORMANCE PARTS

4. If equipped, remove the bleeder screw cap.

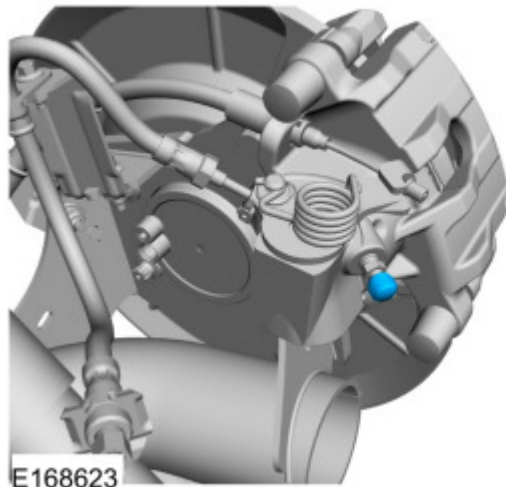

5. Partially fill a clean brake fluid container with clean specified brake fluid.

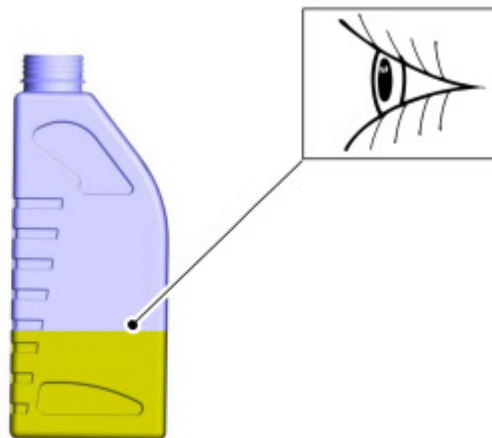

Factory Ford shop manuals are available from Helm Publications, 1-800-782-4356



FORD PERFORMANCE

M-2300-WR Focus ST Performance RS Rear Brake Kit

NO PART OF THIS DOCUMENT MAY BE REPRODUCED WITHOUT PRIOR AGREEMENT AND WRITTEN PERMISSION OF FORD PERFORMANCE PARTS

- Submerge a hose into the brake fluid in the container and connect the hose to bleeder screw.

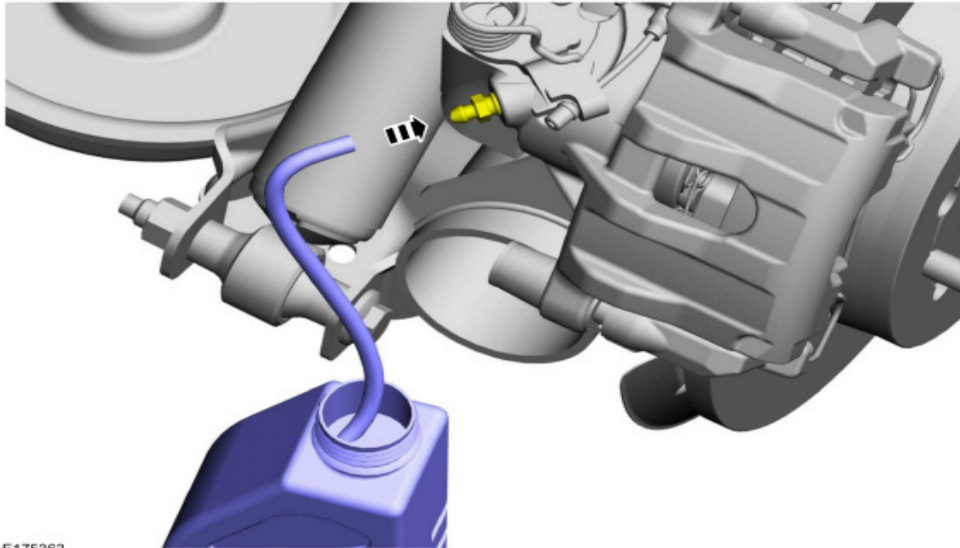

-
-
-
-
-
-
-

Loosen the bleeder screw 180°

Leave open until clear, bubble-free brake fluid flows, then tighten the bleeder screw.

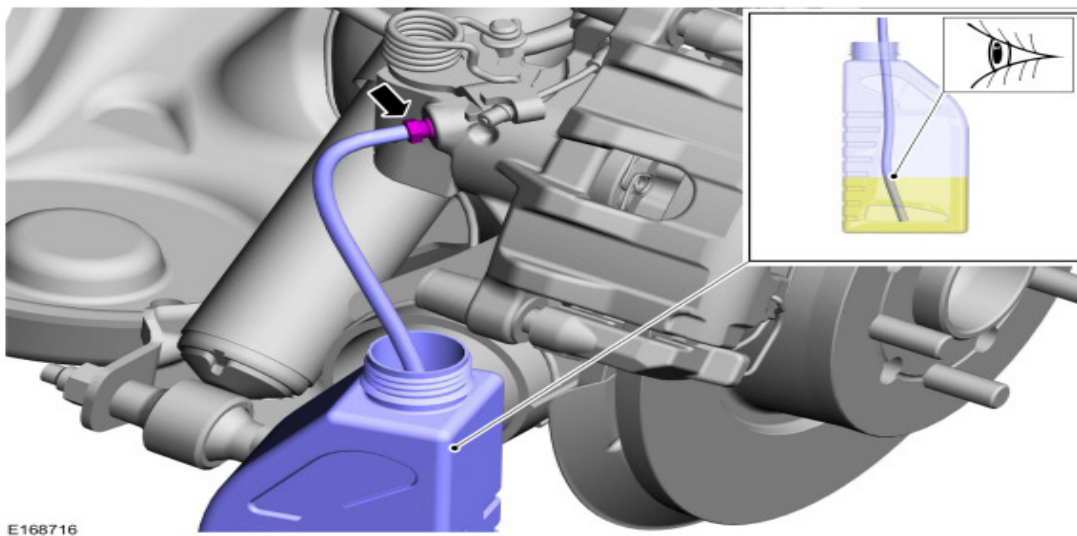

Factory Ford shop manuals are available from Helm Publications, 1-800-782-4356



FORD PERFORMANCE

M-2300-WR Focus ST Performance RS Rear Brake Kit

NO PART OF THIS DOCUMENT MAY BE REPRODUCED WITHOUT PRIOR AGREEMENT AND WRITTEN PERMISSION OF FORD PERFORMANCE PARTS

8. Disconnect the hose and tighten the bleeder screw to specification.

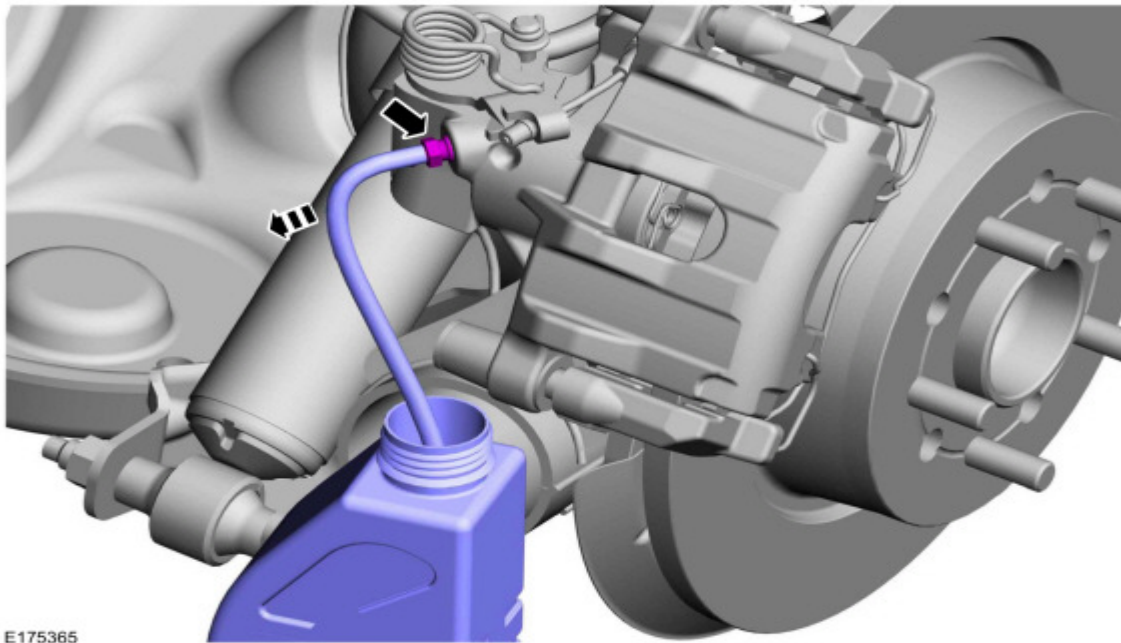

9. Repeat steps 2-8 at the remaining wheel ends.

Vehicles with rear integral parking brake calipers

NOTE: *Due to the complexity of the fluid path within the rear integral parking brake calipers, it is necessary to apply and release the parking brake during the bleed procedure.*

1. Apply and release the parking brake 5 times.
2. Loosen the bleeder screw 180°
3. Leave open until clear, bubble-free fluid flows and then tighten the bleeder screw to specification.
4. Repeat as necessary.

Factory Ford shop manuals are available from Helm Publications, 1-800-782-4356



FORD PERFORMANCE

M-2300-WR Focus ST Performance RS Rear Brake Kit

NO PART OF THIS DOCUMENT MAY BE REPRODUCED WITHOUT PRIOR AGREEMENT AND WRITTEN PERMISSION OF FORD PERFORMANCE PARTS

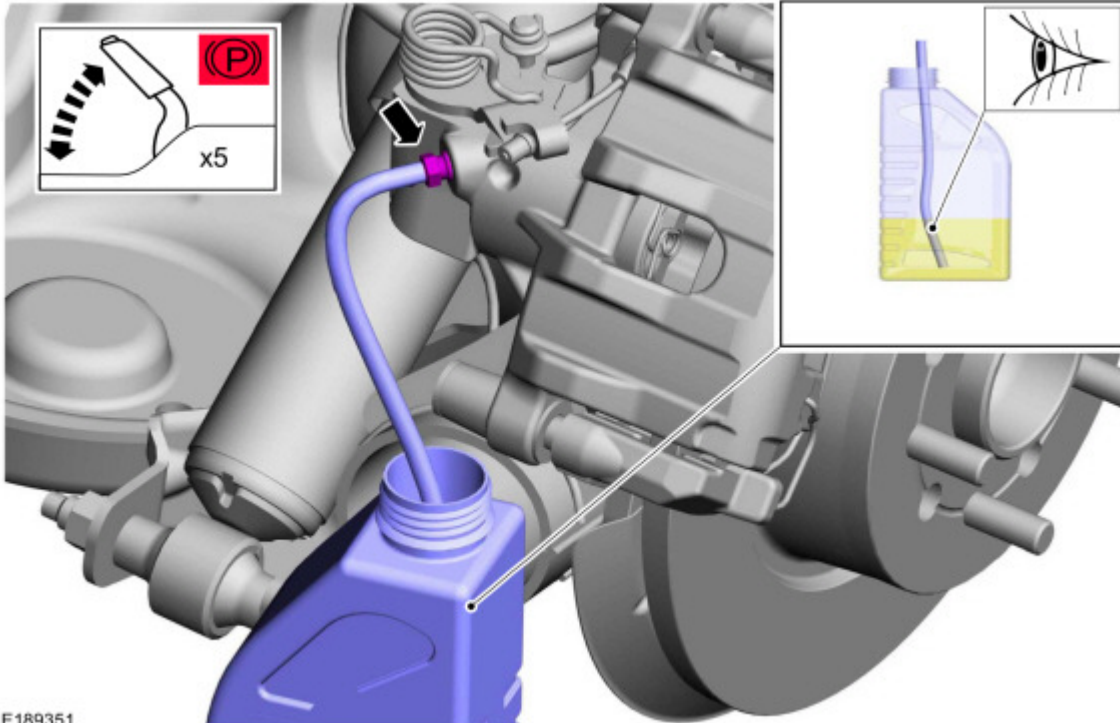

10. If equipped, install the bleeder screw cap.

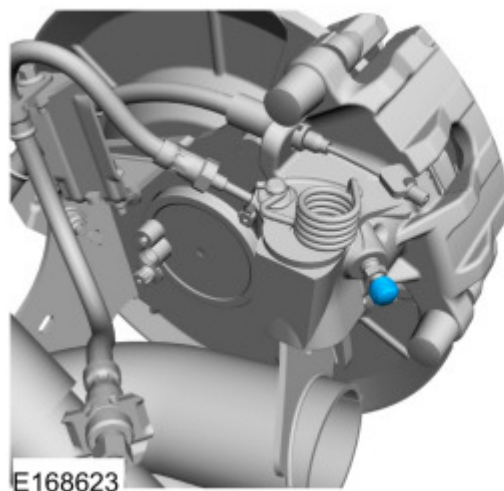

Factory Ford shop manuals are available from Helm Publications, 1-800-782-4356



FORD PERFORMANCE

M-2300-WR Focus ST Performance RS Rear Brake Kit

NO PART OF THIS DOCUMENT MAY BE REPRODUCED WITHOUT PRIOR AGREEMENT AND WRITTEN PERMISSION OF FORD PERFORMANCE PARTS

11. Lower the vehicle.
12. Close the bleeder tank valve and release the pressure.
13. Fill the reservoir with clean, specified brake fluid.

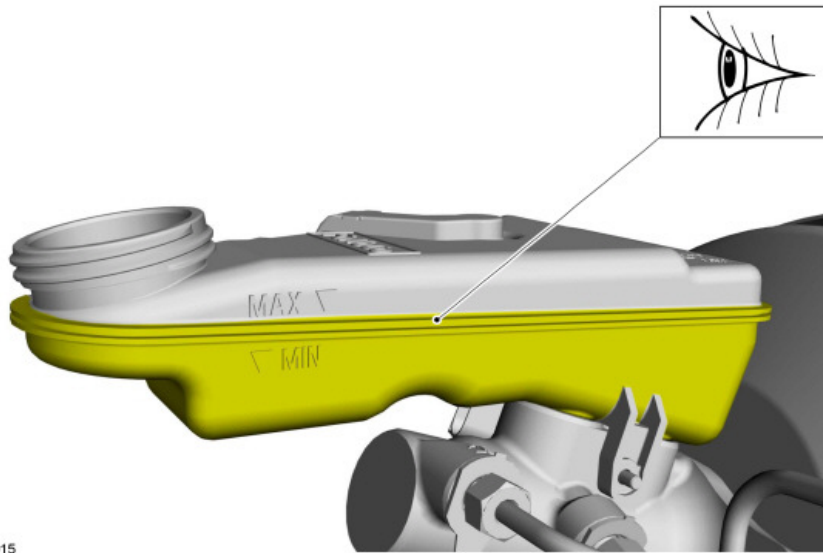

E139915

14. Install the brake fluid reservoir cap.

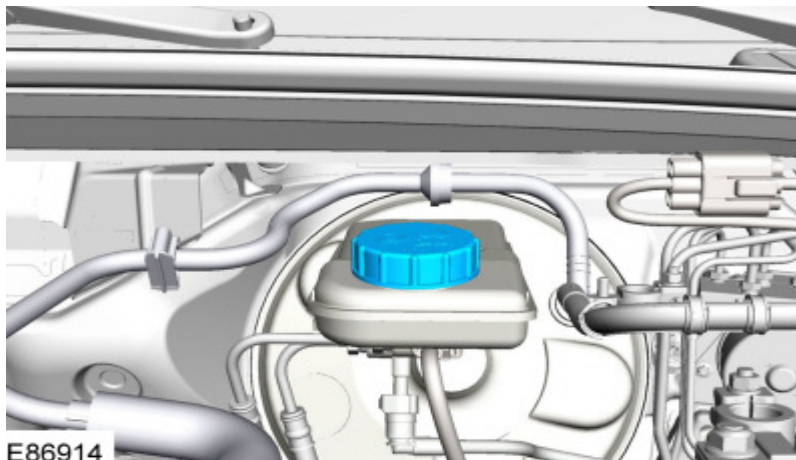

E86914

Factory Ford shop manuals are available from Helm Publications, 1-800-782-4356



FORD PERFORMANCE

M-2300-WR Focus ST Performance RS Rear Brake Kit

NO PART OF THIS DOCUMENT MAY BE REPRODUCED WITHOUT PRIOR AGREEMENT AND WRITTEN PERMISSION OF FORD PERFORMANCE PARTS

Install wheel and tire

⚠ WARNING: When a wheel is installed, always remove any corrosion, dirt or foreign material present on the mounting surface of the wheel and the mounting surface of the wheel hub, brake drum or brake disc. Make sure that any fasteners that attach the rotor to the hub are secured so they do not interfere with the mounting surfaces of the wheel. Failure to follow these instructions when installing wheels may result in the wheel nuts loosening and the wheel coming off while the vehicle is in motion, which could result in loss of control, leading to serious injury or death to vehicle occupant(s).

NOTICE: Make sure to apply a thin coat of anti-seize lubrication only to the interface between the wheel pilot bore and the hub pilot. Do not allow the anti-seize to make contact with the wheel-to-brake disc/drum mounting surface, wheel studs, wheel nuts, brake pads or brake disc friction surfaces or damage to components may occur.

Clean the specified component with the specified material. Apply the substance from the specified tube. Apply a thin coat of anti-seize lubrication to the interface between the wheel pilot bore and the hub pilot.
Material: High Temperature Nickel Anti-Seize Lubricant / XL-2

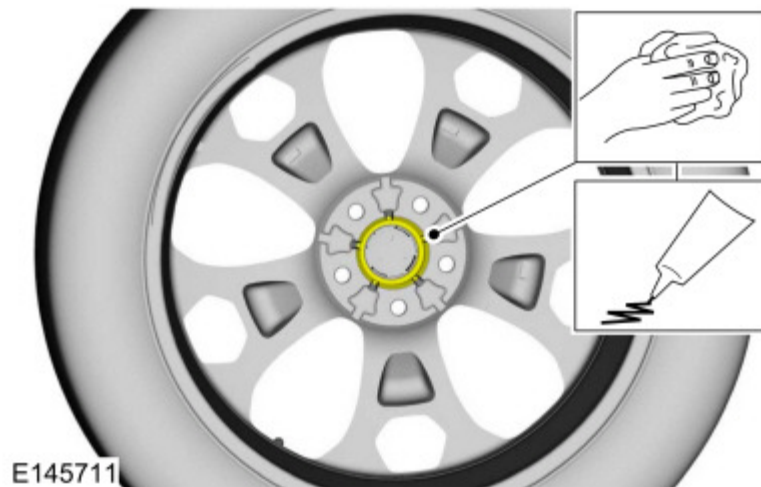

Factory Ford shop manuals are available from Helm Publications, 1-800-782-4356



FORD PERFORMANCE

M-2300-WR Focus ST Performance RS Rear Brake Kit

NO PART OF THIS DOCUMENT MAY BE REPRODUCED WITHOUT PRIOR AGREEMENT AND WRITTEN PERMISSION OF FORD PERFORMANCE PARTS

Finger tight only at this stage.
Install the wheel and the wheel nuts.

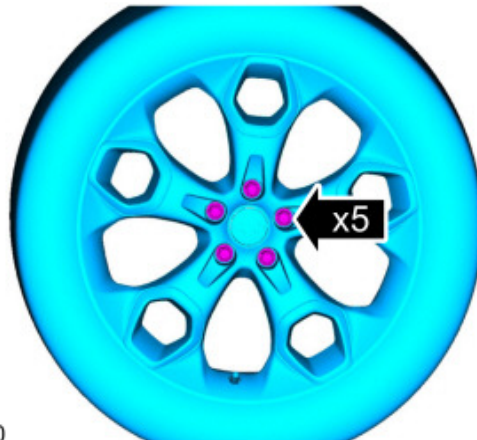

E145710

WARNING: Retighten wheel nuts within 160 km (100 mi) after a wheel is reinstalled. Wheels can loosen after initial tightening. Failure to follow this instruction may result in serious injury to vehicle occupant(s).

NOTICE: Failure to tighten the wheel nuts in a star/cross pattern can result in high brake disc runout, which accelerates the development of brake roughness, shudder and vibration.

NOTE: The wheel nut torque specification is for clean, dry wheel stud and wheel nut threads.

NOTE: Final tightening to be performed with vehicle resting on tires.

Tighten the wheel nuts in the sequence shown.

Torque: 100 lb.ft (135 Nm)

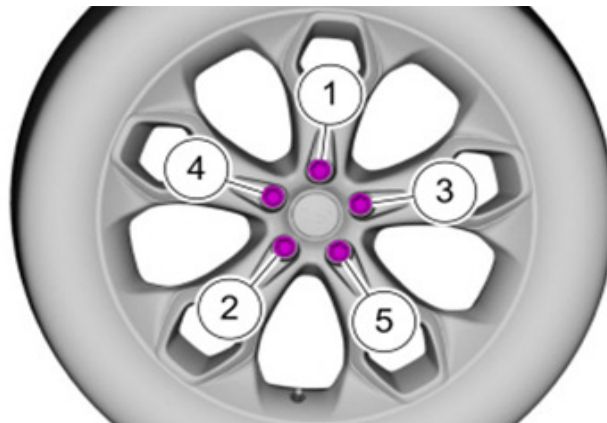

Factory Ford shop manuals are available from Helm Publications, 1-800-782-4356