



FORD PERFORMANCE

# Installation Manual M-6017-M52SC 5.2L Control Pack

NO PART OF THIS DOCUMENT MAY BE REPRODUCED WITHOUT PRIOR AGREEMENT AND WRITTEN PERMISSION OF FORD PERFORMANCE PARTS

Please visit [www.performanceparts.ford.com](http://www.performanceparts.ford.com) for the most current instruction and warranty information.

PLEASE READ ALL OF THE FOLLOWING INSTRUCTIONS CAREFULLY PRIOR TO INSTALLATION. AT ANY TIME YOU DO NOT UNDERSTAND THE INSTRUCTIONS, PLEASE CALL THE FORD PERFORMANCE TECHLINE AT 1-800-367-3788

## 5.2L Control Pack Installation Manual



### TABLE OF CONTENTS

Section	Topic	Page
1.0	Introduction .....	2
2.0	Overview .....	2
3.0	Included/Required Components .....	2-5
4.0	Pre-Installation of Harness and Parts .....	5-8
5.0	Controls Pack Harness Installation Instructions .....	9-11
6.0	Ford Performance Power Distribution Box Installation .....	12-13
7.0	Fuel System .....	14-15
8.0	Initial Start-Up .....	15
9.0	Ignition Switch Wire Schematic .....	15-17
10.0	Fuses & Relays .....	18
11.0	Troubleshooting Tips .....	19
12.0	Connector Faces .....	19-32
13.0	CAN Message Definition .....	33
14.0	Wiring Schematic (Control Pack & Transmission Harness) .....	34-35

Factory Ford shop manuals are available from Helm Publications, 1-800-782-4356

NO PART OF THIS DOCUMENT MAY BE REPRODUCED WITHOUT PRIOR AGREEMENT AND WRITTEN PERMISSION OF FORD PERFORMANCE PARTS

## 1.0 - Introduction

This kit was developed by Ford Performance in order to allow performance enthusiasts the to install our 5.2L Mustang GT500 760HP Crate Engine (Ford Performance P/N: M-6007-M52SC) into the application of their choice. The system supports use of manual transmission only, Tremec T-56 (M-7003-M6266) or manual transmission with similar specifications.

Note: Cruise control is not available with this system. GPS or drive shaft speed sensors are suggested for vehicle speed.

## 2.0 - Overview

This booklet provides a step by step guide for the preparation and installation of the control pack. Please read the instructions thoroughly before starting the installation. If you have any questions, contact Ford Performance Technical Support at (800) 367-3788.

## 3.0 – Included/Required Components

Below is a Bill of Materials included in this kit

Part #	Description
LR3Z-12A650-JANP	5.2L PCM with Calibration
CM-14A006-502MAA	5.2L Control Pack Main Harness
CM-14A006-MTRANS	5.2L Control Pack Manual Trans Harness
CR3Z-9F836-E	Accelerator Pedal Assembly
KR3Z-9F472-A	RH UEGO Sensor
KR3Z-9F472-B	LH UEGO Sensor
6G9Z-11A152-A	Clutch Position Switch
FR3Z-12A647-B	Ambient Air Temperature Sensor

### 3.1 Powertrain Control Module (PCM)

- The PCM is the central processing unit for engine operation. Input data/engine operation feedback is provided from each of the engine's sensors connected to the PCM via wiring leads. This input data is used to perform calculations that in turn adjust fuel quantity and spark timing according to varying driver demand (ie – accelerator pedal input).
- The PCM in this Control Pack has a custom software and calibration dataset which were specifically modified/developed by Ford Performance engineers to provide peak performance and reliability with the 5.2L Mustang GT500 760HP Crate Engine (Ford Performance P/N: M-6007-M52SC)

#### PCM Calibration Application Notes:

- The calibration provided in this PCM works with a mechanically regulated return style fuel system. See Section 7 of this manual for more information on fuel system requirements for this PCM.
- The 5.2L Crate Engine uses MAP (Manifold Absolute Pressure) for air density calculation. You can use the air intake tube/air box system of your choice. You will however need an IAT (Intake Air Temperature) sensor (not included) Ford part number DS7Z-12A697-A mounted in this assembly for proper engine operation.
- Premium Fuel Only (91 Octane or higher).

NOTE: Due to the fuel system requirement described above, installation of this PCM in ANY Production Mustang vehicle will result in a no-start condition!

Factory Ford shop manuals are available from Helm Publications, 1-800-782-4356

NO PART OF THIS DOCUMENT MAY BE REPRODUCED WITHOUT PRIOR AGREEMENT AND WRITTEN PERMISSION OF FORD PERFORMANCE PARTS

### 3.2 Control Pack Wiring Harness

- The control pack wiring harness has pre-determined lengths that will dictate the location of certain supporting components as well as the locations of fixed components on the drive train.

### 3.2 Accelerator Pedal Position Sensor (APPS)

- The accelerator pedal assembly includes a pair of integrated pedal position sensors (APPS1/APPS2). This pedal has electrical properties designed specifically for correct interface with PCM and is required for proper engine operation.

### 3.3 Fuel Supply System (Not All Components are Included)

- See Section 7 – Fuel System of this manual for fuel pump and regulator requirement.

### 3.4 UEGO (O2) Sensors

- One UEGO sensor is used per cylinder bank (1 upstream) to provide wide band feedback to the PCM for closed loop air fuel ratio control by measuring the quantity of oxygen present in the exhaust stream leaving the combustion chamber.
- Each sensor is supplied with a light coating of anti-seize lubricant on its threads. Please use caution when installing as this lubricant will damage the sensor element, so make sure no lubricant comes in contact with the sensor element (tip).
- Tighten to 35 lb-ft (48 Nm)

**NOTE:** Do not splice, lengthen, or otherwise modify the sensor wiring. Doing so will adversely affect the sensor performance and reliability of the signal. You may lengthen the connector leads from the harness side if necessary, by splicing, soldering and shrink wrapping the splices. The engine harness and controls package is designed to operate with the UEGO sensors in model year 2020 5.2L Mustang stock locations.

The engine harness and control pack is designed to operate with the UEGO sensors in the 5.2L SC Mustang stock locations. Moving the sensors to alternate locations can result in the need to recalibrate the PCM.

Here are some tips if sensors have to be relocated:

The best option is to locate the sensor so it is sampling from all 4 cylinders.

If your header design will not allow you to sample all 4 cylinders without harness modifications, a better alternative is locating the UEGO sensor to sample from a single cylinder. The cylinders that have (on average) the closest A/F ratio to the bank average are cylinder #4 (on bank 1) and cylinder #7 (on bank 2). If that's not possible due to packaging constraints, the next best choices are cylinder #3 (on bank 1) and cylinder #8 (on bank 2). Calibration required!

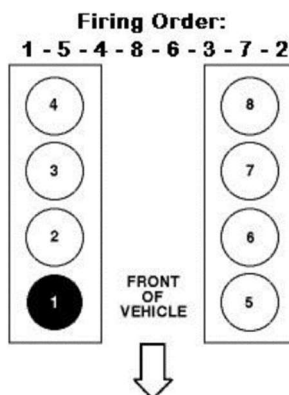

Factory Ford shop manuals are available from Helm Publications, 1-800-782-4356



FORD PERFORMANCE

## Installation Manual M-6017-M52SC 5.2L Control Pack

NO PART OF THIS DOCUMENT MAY BE REPRODUCED WITHOUT PRIOR AGREEMENT AND WRITTEN PERMISSION OF FORD PERFORMANCE PARTS

### 3.5 Plastic Bag of Assorted Items

- Inline Fuse
- Fuse Holder
- 6-Way IP Pigtail
- Misc. Hardware



### 3.6 Ambient Air Temperature Sensor (AAT)

- The AAT must be installed in the vehicle forward of the radiator or other heat exchangers.
- The installation location must be in the flow of fresh air to provide optimum performance as it effects the calculation of the delivered fuel and spark timing.

### 3.7 Clutch Pedal Position Sensor (CPP)

- The switch translates the clutch pedal position to the PCM.
- The bottom travel switch also acts as a starter safety interlock. The starter motor will not energize until the clutch has been fully depressed.
- The CPP switch is Normally Open (IE – Clutch Pedal NOT fully depressed); Closed with Clutch Pedal fully depressed
- Clutch pedal assembly P/N: BV61-7B633-AA is available through an Authorized Ford Parts dealer. Includes a clutch pedal and mounting bracket with provisions to hold both the Top and Bottom of Travel switches in the appropriate locations.

### 3.8 Intake Air Temperature Sensor (IAT) (SOLD SEPARATELY) Ford Part # DS7Z-12A697-A

- The IAT measure the intake air charge temperature between the air filter box and throttle body.
- You can use the intake tube & air box of your choice, but the IAT will need to be mounted in the intake air stream for proper engine operation.

**WARNING:** DO NOT BYPASS THE STARTER INTERLOCK. DOING SO CREATES A HAZARD TO THOSE IN AND AROUND THE VEHICLE AS THE STARTER CAN OPERATE WITH THE TRANSMISSION IN GEAR AND THE CLUTCH PEDAL ENGAGED.

Factory Ford shop manuals are available from Helm Publications, 1-800-782-4356



FORD PERFORMANCE

# Installation Manual M-6017-M52SC 5.2L Control Pack

NO PART OF THIS DOCUMENT MAY BE REPRODUCED WITHOUT PRIOR AGREEMENT AND WRITTEN PERMISSION OF FORD PERFORMANCE PARTS

### 3.9 Control Pack Wiring Harness

- Connects to vehicle battery and inline connector on engine harness
- Contains Ford Performance Power Distribution Box (FPPDB) and high power inline fuse
- Electrical Connection to Accelerator Pedal (APPS)
- Wire leads for Ignition Switch and Starter
- Transmission harness contains connections for UEGO sensors and PCM connection
- Data Link Connector for reading Diagnostic Trouble Codes (DTC's)
- Check Engine/Malfunction Indicator Lamp (MIL) for visual indication of engine control system fault code presence
  - Only the MIL included in the this kit will illuminate if a fault exist.

NOTE: MIL will stay illuminated when the ignition is ON and engine is NOT running; this condition does not indicate a system fault. Not all DSC's will cause the MIL to illuminate.

## 4.0 - Pre-Installation of Harness and Parts

### 4.1 Planning

The following is a list of key factors to consider before any installation takes place:

- PCM mounting location is limited by the lengths of the corresponding leads which connect to the PCM, located at the right front corner of the engine. These leads are an integral part of the ENGINE HARNESS
- Ford Performance Power Distribution Box must be mounted within 60" of the vehicle battery as dictated by the Battery+/ Ground Lead Lengths of the controls pack wiring harness
- Lay out the harness and components first in order to ensure that the wiring leads will reach everywhere you intend them to. This is a good reality check before you drill any holes or mount any components!

### 4.2 Connector ID

Item	Connector #	Description	Item	Connector #	Description
A	-	FPPDB	O	C1743	Intercooler Coolant Temp Sensor
B	-	Ground	P	C128	Mass Air Flow (Not Used w/ 5.2L)
C	C160A	Inline to IP Pigtail	Q	C129	Intake Air Temp
D	C2051	Data Link Connector & MIL	R	C132	Ambient Air Temp
E	C257	CPP-BT	S	C102A	Alternator (Not Shown)
F	C2040	Accelerator Position Sensor	T	C90	PCM Connector (Trans Harness)
G	C8	PATS Module	U	C1571	UEGO RH Bank 1 (Upstream)
H	-	Starter Solenoid	V	C1572	UEGO LH Bank 2 (Upstream)
I	-	Cooling Fan Feed	W	C141	HO2S RH Bank 1 (Not Used w/ 5.2L)
J	-	HSCAN (+/-)	X	C142	HO2S LH Bank 2 (Not Used w/ 5.2L)
K	C146	Inline to Engine Harness	Y	C1A	Inline to Control Pack Harness
L	C1B	Inline to Trans Harness	-	-	-
M	C175B	PCM Connector (Control Pack)	-	-	-
N	C1217	Intercooler Coolant Pump Control	-	-	-

Table 1 – Summary of Controls Pack Connectors

Factory Ford shop manuals are available from Helm Publications, 1-800-782-4356



FORD PERFORMANCE

# Installation Manual

## M-6017-M52SC 5.2L Control Pack

NO PART OF THIS DOCUMENT MAY BE REPRODUCED WITHOUT PRIOR AGREEMENT AND WRITTEN PERMISSION OF FORD PERFORMANCE PARTS

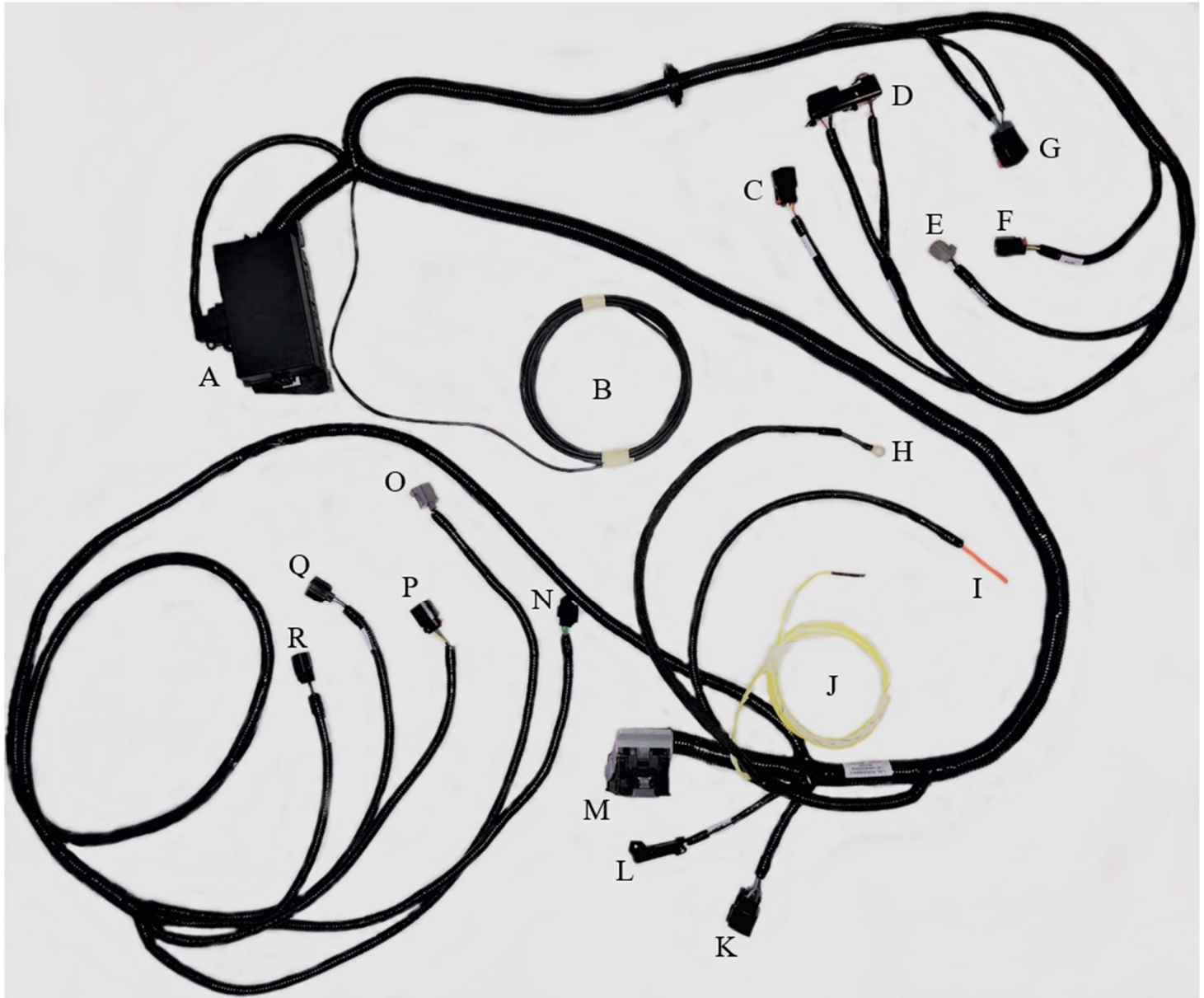

Figure 1a - Controls Pack Wiring Harness Components

Factory Ford shop manuals are available from Helm Publications, 1-800-782-4356



FORD PERFORMANCE

# Installation Manual

## M-6017-M52SC 5.2L Control Pack

NO PART OF THIS DOCUMENT MAY BE REPRODUCED WITHOUT PRIOR AGREEMENT AND WRITTEN PERMISSION OF FORD PERFORMANCE PARTS



Figure 1b - Controls Pack Wiring Harness Components

Factory Ford shop manuals are available from Helm Publications, 1-800-782-4356

NO PART OF THIS DOCUMENT MAY BE REPRODUCED WITHOUT PRIOR AGREEMENT AND WRITTEN PERMISSION OF FORD PERFORMANCE PARTS

### 4.4 Engine Harness Routing

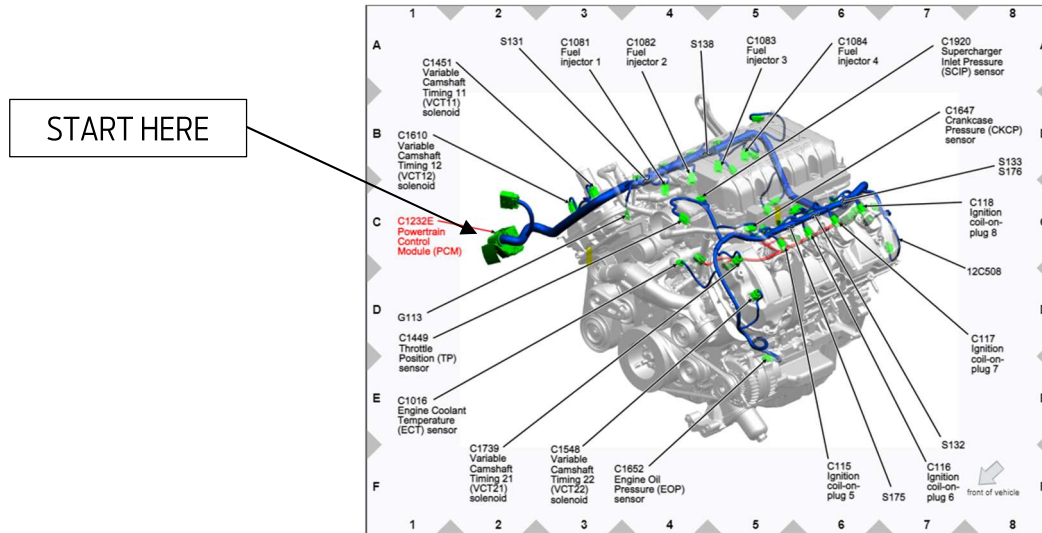

Figure 2 – Front View of Engine.

**NOTE:** The wire harness shown in blue above is the ENGINE HARNESS that comes standard with the 5.2L GT500 760HP Crate Engine (Ford Performance P/N: M-6007-M52SC); THIS IS NOT THE CONTROLS PACK WIRING HARNESS.





FORD PERFORMANCE

## Installation Manual M-6017-M52SC 5.2L Control Pack

NO PART OF THIS DOCUMENT MAY BE REPRODUCED WITHOUT PRIOR AGREEMENT AND WRITTEN PERMISSION OF FORD PERFORMANCE PARTS

### 5.0 - Control Pack Harness Installation Instructions

#### 5.1 – Main Control Pack & Transmission Harness

**NOTE:** To avoid electrical shock and/or damage to sensitive electrical control system components, before beginning any work, remove the vehicle's Negative Battery Terminal and place a rag or towel between it and the Battery Negative Post. The Negative Battery Terminal is not to be reinstalled until the last step of the installation.

1. Identify proper mounting location for the PCM, Power Distribution Box (Item A) & Inline Fuse Holder. Locate the PCM connector (C175E) on the engine harness as indicated in Figure 2 by the "START HERE" arrow.
2. If a stock PCM is present in the vehicle (only the supplied control pack PCM), unplug it and store it in a cool, dry place in case it is needed in the future.
3. Plug C175E (from the engine harness), C175B (Item M from the control pack harness) and C90 (Item T from transmission harness) into the control pack PCM; once plugged-in, use a zip-tie to tie the bundle of wires exiting each connector back together. Route the transmission harness so that both UEGO sensor connectors (C1571 & C1572) are able to reach their corresponding sensors. Connect the UEGO sensors and 1-way inline connectors (C1A & C1B). In the steps that follow, we will be repeating this process of using zip-ties to piggy-back/tie the harness to the existing engine harness approximately every 200 mm along the engine harness.
4. Connect the in-line connector (C146) from the controls pack harness to the mating connector on the engine harness.
5. Connect Alternator Connector (C102A), Intake Air Temperature (IAT) Sensor Connector (C129), Ambient Air Temperature Sensor Connector (C132), Intercooler Coolant Temperature Sensor (C1743), and Intercooler Coolant Pump (C1217) to their respective locations being sure to avoid any pinch-points or exhaust hot-spots.
6. Connect Blunt-cut orange 10AWG cooling fan lead and Starter Lead Eyelet to their respective locations.
7. Connect the ground eyelet (Item B) to a reliable ground point on the chassis or engine block.

**NOTE:** The grommet needs to be properly installed in the firewall of your vehicle to protect the Control Pack Harness that passes through to the passenger compartment. All connections previously mentioned are located under hood. All connections mentioned from this point forward are located in the passenger compartment.

8. Identify proper mounting location for the Accelerator pedal, Clutch Pedal Position and Ignition Switch (purchased separately).
9. Identify mounting location for the bracket with OBDII connector and Malfunctioning Light (Item D).
10. Route C160A (Item C) to approximately the base of the steering wheel to be connected later.
11. Connect APPS connector (C2040) and Clutch Pedal Position connector (C257) to their respective locations. NOTE: Connector (Item G) can be used for power (key on/hot at all times), ground and HSCAN (if desired for your application). See Section 12 & 13 for more information.
12. Locate the 6-way I/P Pigtail connector with blunt leads (C160B), to mate with C106A and continue to Section 5.2.

**NOTE:** \*Connector Removal Procedure\* If there are connectors that will not be used in your application you can cut the routing leading-up to the unused connector and individually heat shrink wrap each wire. To ensure that the wires are completely isolated from one another, and the outside environment, wrap the heat-shrunked wire bundle in electrical tape to provide an additional layer of protection from moisture and dirt.

Factory Ford shop manuals are available from Helm Publications, 1-800-782-4356

NO PART OF THIS DOCUMENT MAY BE REPRODUCED WITHOUT PRIOR AGREEMENT AND WRITTEN PERMISSION OF FORD PERFORMANCE PARTS

5.2 - 6-way I/P Pigtail Connection Details



Figure 3 – Connector C160B

The 6-way pigtail is to be connected according to the chart below. See also the diagrams on the following pages for illustrations of wire connection points, based on the ignition/starter switches that you intend to use. Setup A uses separate toggle switches for ignition and starter inputs, while Setup B uses an ignition cylinder with a key.

Cavity	Lead Label	Wire Color	Description
1	Fuel Pump Relay Out	GN	Provides +12V to the fuel pump
2	-	-	-
3	Starter Motor Request (SMR)	Light Blue	Apply +12V to send a request to the PCM to energize the starter solenoid
4	-	-	-
5	Ignition Relay Trigger	Light Green	Apply +12V to energize the ignition relay/wake-up the system
6	-	-	-

Locate each of the blunt leads. Before soldering any wiring, you will first need to decide which set-up you will pursue by referencing Set-up A and Set-up B on pages 16 and 17.

Connect the following REQUIRED blunt leads as follows:

**Blunt Lead 1 – Fuel Pump Relay Out (Dark Green):** Connect to Fuel Pump positive. Separate ground for fuel pump must be provided. The fuel pump will start running any time key is on, then if you don't start the engine the computer will turn it off after a couple of seconds.

**NOTE:** The fuel pump will start running any time the key is on, then if you don't start the engine, the PCM will turn it off after a couple of seconds.



FORD PERFORMANCE

## Installation Manual M-6017-M52SC 5.2L Control Pack

NO PART OF THIS DOCUMENT MAY BE REPRODUCED WITHOUT PRIOR AGREEMENT AND WRITTEN PERMISSION OF FORD PERFORMANCE PARTS

### Blunt Lead 3 – Starter Motor Request (Light Blue):

#### Set-up A:

Connect to input node of starter momentary switch so that 12 volts is provided when engine starting is requested.

#### Set-up B:

Connect to 'Start' output node of ignition cylinder so that 12 volts is provided when engine starting is requested.

### Blunt Lead 5 – Ignition Relay Trigger (Light Green):

#### Set-up A:

Connect this wire to the output side of the ignition toggle switch so that 12 volts is provided when the key is in the 'Start' (cranking) and 'Run' positions. It is imperative that this circuit be reliable, the PCM will interpret an intermittent voltage on this signal as a request to shut down the engine!

#### Set-up B:

Connect to the 'Start/Run' output node of ignition cylinder so that 12 volts is provided when engine starting is requested. It is imperative that this circuit be reliable, the PCM will interpret an intermittent voltage on this signal as a request to shut down the engine!

NOTE: If your engine shuts down after a hard launch, check here first.

Once all of the blunt lead connections have been soldered onto their appropriate location, insert the 16-way I/P Pigtail connector into C160A.

### \* Important Note on the Starting System \*

This kit includes connections and installation instructions for PCM controlled engine starting; however, it is not required that the customer utilize this option. Customers may choose to use their existing non-PCM controlled starting system if desired. If non-PCM controlled starting is used, any unused blunt leads should be cut to ~2" length and sealed using heat shrink.

Factory Ford shop manuals are available from Helm Publications, 1-800-782-4356



FORD PERFORMANCE

## Installation Manual M-6017-M52SC 5.2L Control Pack

NO PART OF THIS DOCUMENT MAY BE REPRODUCED WITHOUT PRIOR AGREEMENT AND WRITTEN PERMISSION OF FORD PERFORMANCE PARTS

### 6.0 - Ford Performance Power Distribution Box Installation

**NOTE:** DO NOT MAKE ANY ELECTRICAL CONNECTIONS TO THE BATTERY TERMINALS UNTIL INSTRUCTED.

1. Before you start, you will need three battery cables for battery positive and ground connections. Two will be used for battery positive and one for battery ground (negative) (purchased separately. 4 AWG recommended). One battery positive lead will be from battery to 250A fuse holder and the other from fuse holder to FPPDB (Item A). One battery positive and the battery ground cable will need a battery clamp at one end and an eyelet at the other. The second battery positive cable will need an eyelet at both ends (battery clamps and eyelets are purchased separately).
2. Carefully remove the nut and washers on both terminals of the in-line fuse holder and set aside.
3. Using the battery positive cable with an eyelet at both ends, place one end onto the in-line fuse holder terminal. Place one washer and nut over the eyelet and tighten down.
4. Locate the power terminal on the FPPDB. NOTE: There is a battery positive blunt lead eyelet already attached to it. Attach the second eyelet from the battery positive cable in Step 3 to the power terminal on FPPDB. Install on the FPPDB terminal in the following order: washer, battery positive cable eyelet, blunt lead eyelet, washer, and nut.
5. Place the Buss 250A fuse onto the fuse holder terminals.
6. Using the eyelet end of the second battery positive cable, place the eyelet on the opposite in-line fuse holder terminal. Place the remaining washer and nut over the eyelet and tighten down.
7. Close the cover of the in-line fuse holder.
8. Being careful not to inadvertently complete the circuit, connect the battery clamp end of the second battery positive cable to the positive terminal of the vehicle battery.

**NOTE:** This lead **MUST** be hot at all times (HAAT). If this lead is connected through a switch, the Keep Alive Memory (KAM) of the PCM will be cleared whenever the switch is opened. This will result in loss of diagnostic trouble codes, adaptive fuel parameters, and other information stored in KAM by the PCM.

9. Verify that you have a good (clean & dry) ground path from the battery negative post to chassis ground. Attach the eyelet end of the battery ground cable to chassis ground. Attach the battery clamp end of the ground cable to the negative terminal of the vehicle battery. NOTE: In general, the resistance from the battery ground post through to the chassis should be less than 0.1 ohm.

**NOTE:** While routing battery cables avoid any sharp edges and use zip-ties to secure the cable approximately every 200 mm.

Factory Ford shop manuals are available from Helm Publications, 1-800-782-4356



NO PART OF THIS DOCUMENT MAY BE REPRODUCED WITHOUT PRIOR AGREEMENT AND WRITTEN PERMISSION OF FORD PERFORMANCE PARTS

### 6.1 Suggested Battery Cable Diagram

Connect the Battery positive to the starter and alternator.

Ground the engine to the chassis.

NOTE: Pay close attention to the vehicle grounds. Many times, electrical issues can be traced back to insufficient ground circuits. Ensuring your vehicle is well grounded now, will save you time and frustration later.

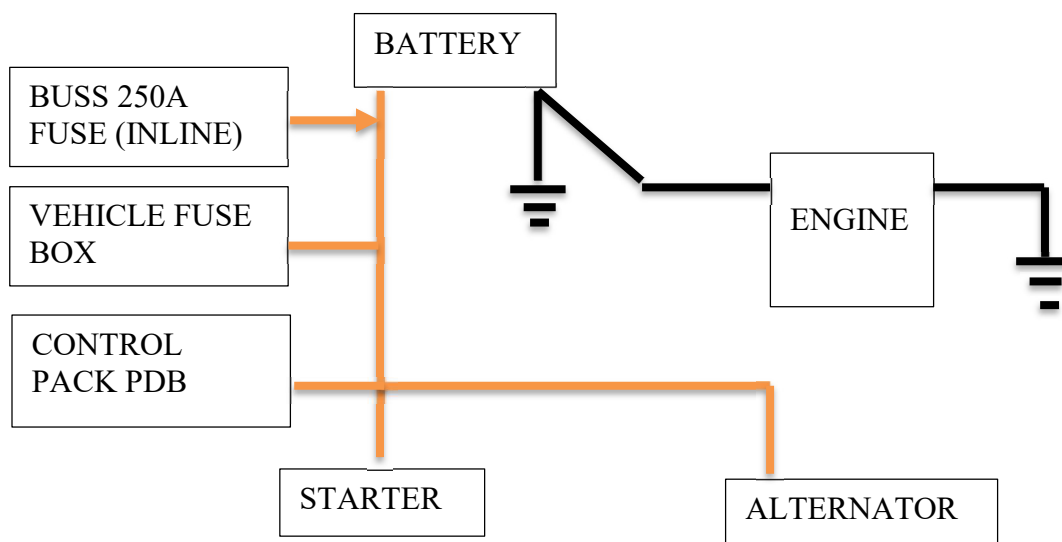



FORD PERFORMANCE

# Installation Manual M-6017-M52SC 5.2L Control Pack

NO PART OF THIS DOCUMENT MAY BE REPRODUCED WITHOUT PRIOR AGREEMENT AND WRITTEN PERMISSION OF FORD PERFORMANCE PARTS

## 7.0 - Fuel System

The PCM is calibrated for a return style fuel system as shown below.

- Set regulator to maintain 71 psi delta fuel pressure across injector.
- Use only AN type fuel fitting to interface with OEM fuel rail.
- Fuel pressure regulator must have reference to manifold vacuum.

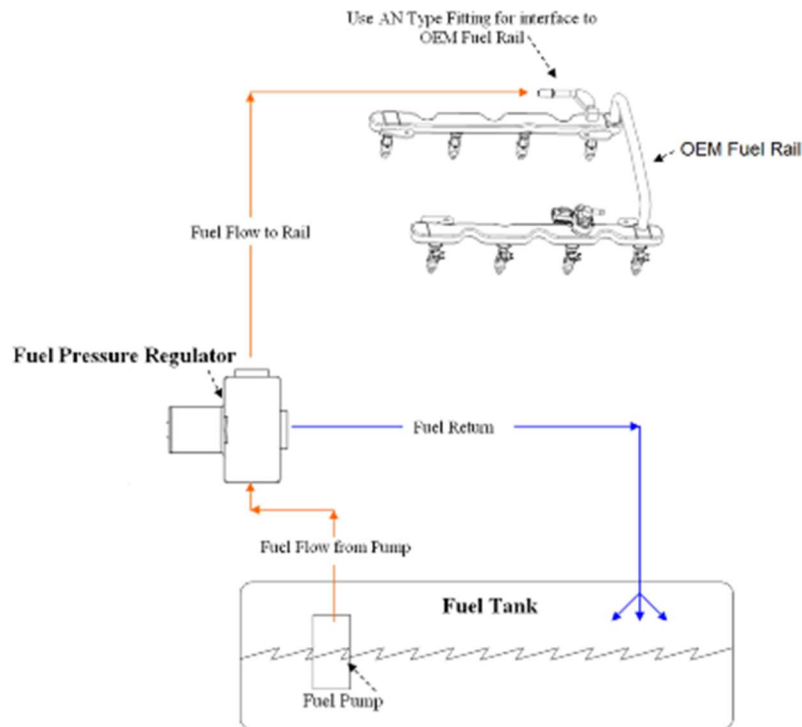

Fuel pump requirements: 500L/Hr minimum at 71 psi

Factory Ford shop manuals are available from Helm Publications, 1-800-782-4356



FORD PERFORMANCE

## Installation Manual M-6017-M52SC 5.2L Control Pack

NO PART OF THIS DOCUMENT MAY BE REPRODUCED WITHOUT PRIOR AGREEMENT AND WRITTEN PERMISSION OF FORD PERFORMANCE PARTS

### 7.1 Fuel Pump Location

A common and often overlooked problem is the location of the fuel pump or pumps. Optimally, the fuel pump should be mounted IN THE TANK to reduce the possibility of pump cavitation. Cavitation is essentially localized boiling caused by a reduction in pressure, generally occurring on the inlet side of a pump. This localized boiling results in fuel vapor bubbles which will reduce the volume of fuel the pump is capable of delivering to the engine. Any reduction in pressure or increase in temperature at the inlet side of the pump increases the chances that cavitation will occur. For this reason, it is always best to either have the pump inside the tank immersed in fuel or (in the case of an external pump) gravity fed, which will increase the pressure on the inlet side of the pump. If the fuel pump has to "pull" the fuel, this will result in a reduction in pressure at the fuel pump inlet potentially allowing cavitation and, thus, vapor bubbles to develop. These vapor bubbles are then drawn into the fuel pump and exit the high-pressure side of the fuel pump as compressed vapor. They travel the entire length of the fuel system and are expelled through the fuel injector. This can cause issues ranging from stumbles and hesitations to engine damage due to insufficient fuel delivery and lean A/F ratios. Sometimes this problem can characterize itself by only appearing when the weather gets warmer, which can confound the diagnosis of the issue. In certain cases, it may seem to only develop when driving on certain surfaces, because pavement reflects more heat than an off-road 4x4 trail. Remember, more heat and lower pressure on the inlet side of the pump means a greater chance of cavitation, which is to be avoided whenever possible. If you are using an external mounted fuel pump, you should run a very coarse (typically around 100 micron) filter on the inlet side of the fuel pump, and a finer (typically around 10 micron) filter on the outlet side of the pump. A paper filter is NOT recommended on the inlet of the fuel pump because it can cause a restriction in fuel flow which, as mentioned previously, can lead to cavitation.

**WARNING:** It is strongly recommended that an inertia switch is incorporated into the fuel pump wiring to turn off the fuel pump in event of an accident.

### 8.0 - Initial Start-Up

**NOTE:** The following information assumes completion of each of the previous steps of this installation manual.

1. Check all fluid levels, electrical and fluid connections.
2. Pressurize the fuel system by turning the key on. Inspect the entire fuel system (from tank to engine) for leaks.

**NOTE:** If any leaks are found, do not proceed further until these have been corrected.

3. Start Engine.
4. Check for leaks and/or noises that may indicate a problem.

**CAUTION:** Be certain to run the vehicle in a well-ventilated area.

### 9.0 – Ignition Switch Wire Schematics

The following two pages detail the two most common wiring configurations—please choose one to complete installation of your control pack kit. You will need to provide 12V HAAT wire yourself.

Factory Ford shop manuals are available from Helm Publications, 1-800-782-4356



FORD PERFORMANCE

# Installation Manual M-6017-M52SC 5.2L Control Pack

NO PART OF THIS DOCUMENT MAY BE REPRODUCED WITHOUT PRIOR AGREEMENT AND WRITTEN PERMISSION OF FORD PERFORMANCE PARTS

## SETUP A

### IGNITION

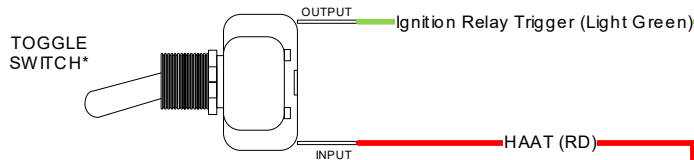

### STARTER

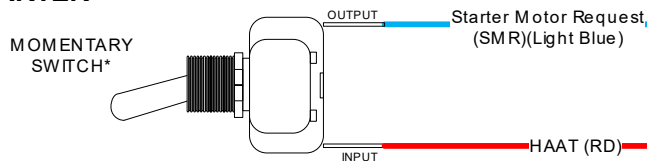

C 160 B

### FUEL PUMP\*

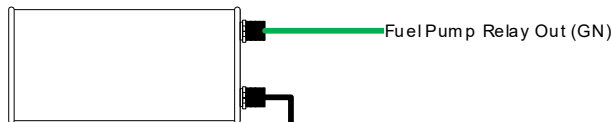

### BATTERY\*

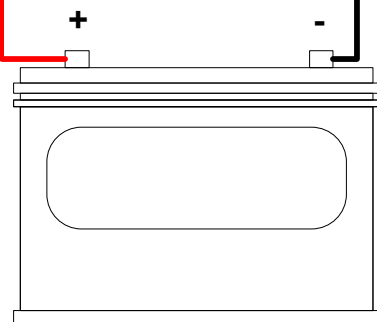

GROUND 14AWG\*

\* = NOT INCLUDED

Factory Ford shop manuals are available from Helm Publications, 1-800-782-4356





FORD PERFORMANCE

# Installation Manual M-6017-M52SC 5.2L Control Pack

NO PART OF THIS DOCUMENT MAY BE REPRODUCED WITHOUT PRIOR AGREEMENT AND WRITTEN PERMISSION OF FORD PERFORMANCE PARTS

## SETUP B

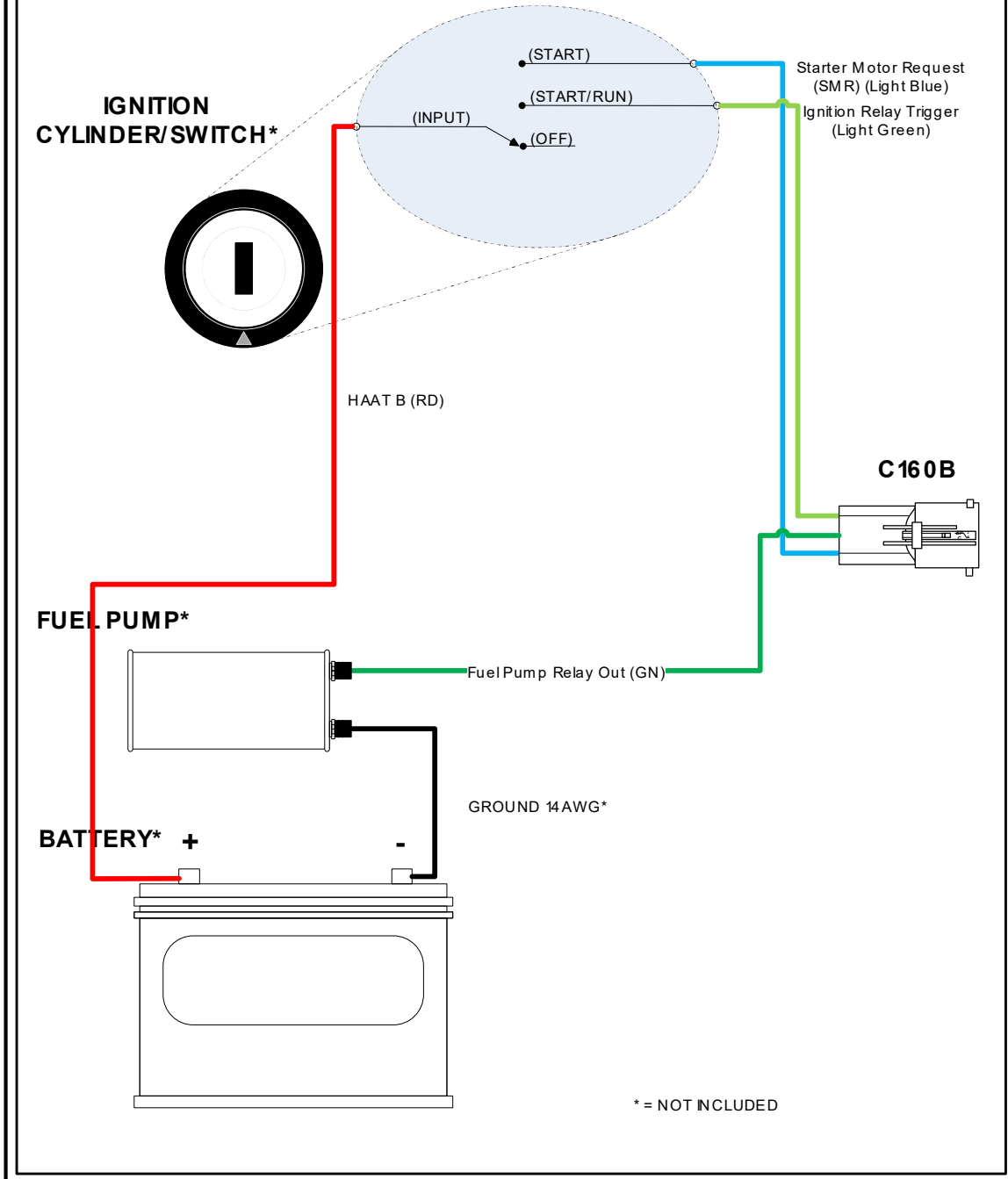

Factory Ford shop manuals are available from Helm Publications, 1-800-782-4356



FORD PERFORMANCE

# Installation Manual M-6017-M52SC 5.2L Control Pack

NO PART OF THIS DOCUMENT MAY BE REPRODUCED WITHOUT PRIOR AGREEMENT AND WRITTEN PERMISSION OF FORD PERFORMANCE PARTS

## 10.0 - Fuses & Relays

The following diagram outlines the array of fuses and relays included in the controls pack wiring harness, and the function of each.

**WARNING:** DO NOT replace any of the fuses with a higher value than those specified below.

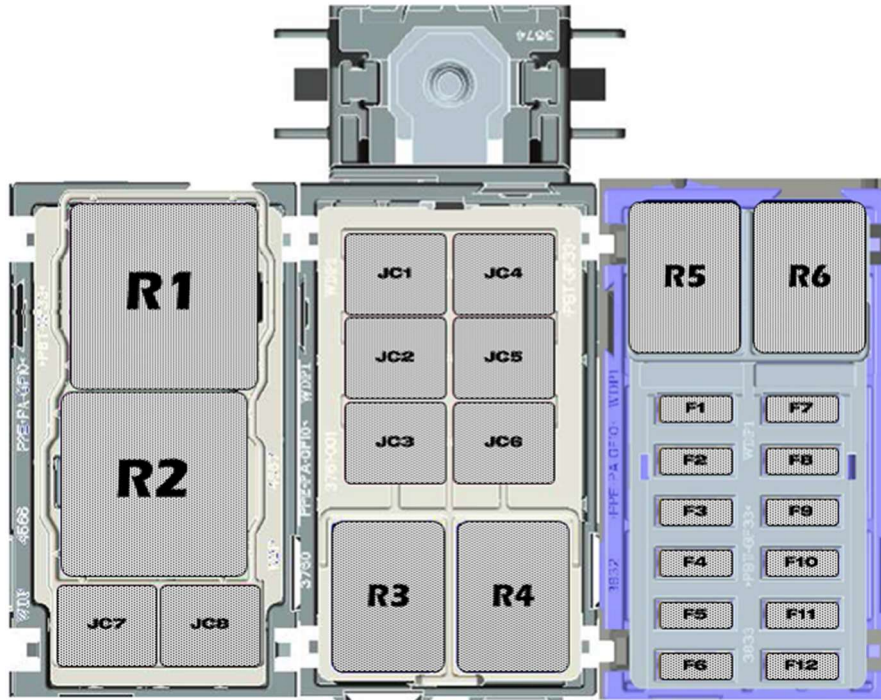

Component ID	Type	Value	Name
JC1	J-Case Fuse	50A	PCM Relay Feed
JC2	J-Case Fuse	50A	Cooling Fan Relay Feed
JC3	J-Case Fuse	30A	Starter Relay Feed
JC4	J-Case Fuse	40A	Fuel Pump Relay Feed
JC5	J-Case Fuse	40A	Ignition Relay Feed
-	-	-	-
JC7	J-Case Fuse	NOT USED	NOT USED
JC8	J-Case Fuse	NOT USED	NOT USED
F1	Minifuse	20A	VPWR1
F2	Minifuse	20A	VPWR2
F3	Minifuse	15A	VPWR3
F4	Minifuse	15A	VPWR4
F5	Minifuse	10A	Ignition Switched A
F6	Minifuse	10A	Ignition Switched B
F7	Minifuse	15A	ICP
F8	Minifuse	15A	Ignition Switched C
F9	Minifuse	15A	VPWR6
F10	Minifuse	10A	HAAT A
F11	Minifuse	10A	HAAT B
-	-	-	-
R1	Power Mini Relay	70A	PCM Relay
R2	Power Mini Relay	70A	Cooling Fan Relay
R3	High Current Micro Relay	40A	Starter Relay
R4	High Current Micro Relay	40A	Fuel Pump Relay
R5	High Current Micro Relay	40A	Ignition Relay
R6	High Current Micro Relay	40A	Ignition Relay

Factory Ford shop manuals are available from Helm Publications, 1-800-782-4356



NO PART OF THIS DOCUMENT MAY BE REPRODUCED WITHOUT PRIOR AGREEMENT AND WRITTEN PERMISSION OF FORD PERFORMANCE PARTS

## 11.0 - Troubleshooting Tips

The following troubleshooting tips are intended to run a few quick tests to diagnose a concern or determine what the issues are before contacting the Ford Performance Techline:

- Double check all ground connections. The wiring included in this kit is extremely sensitive to ground issues. Secure all the connections (chassis grounds & vehicle battery negative post). Do a continuity test with reliable DVOM (Digital Volt Ohm Meter) between all your ground terminals and battery negative post.
- Check all reference voltages. Use a DVOM to measure the voltage at each sensor. It should read 5V.
- If none of the sensors or components have power, check the ignition switch, ignition relay R6, and PCM relay R1 wiring. It should have 12V at both relay outputs with the ignition on. This is fused via F5 and F1 separately. Use a DVOM to measure the voltage at F5 and F1, to confirm that 12V is present. Use the small holes on the mini fuses to probe and measure voltage.
- If the sensor and relay measured voltages are correct, but the engine does not crank, check the starter switch and starter relay R3 wiring. 12V should be present at the relay output when the ignition is in the crank position. Measure the voltage at the starter solenoid eyelet to confirm 12V is present during cranking.
- If your engine only cranks, but does not start, a fuel system malfunction could be the cause. First check that 12V is present at fuel pump +, and all injectors when the key is in the on position. Measure the fuel pressure at the fuel rail, it should increase when the key is cycled to on.

## 12.0 - Connector Faces

### 12.1 Control Pack Main Harness

C129: Intake Air Temperature Sensor

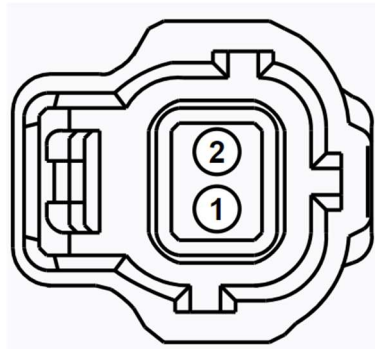

Circuit ID	AWG	Color	Function	Cavity
VE740C	20	VT	IAT	1
RH433	20	BK	SIGRTN	2



FORD PERFORMANCE

# Installation Manual M-6017-M52SC 5.2L Control Pack

NO PART OF THIS DOCUMENT MAY BE REPRODUCED WITHOUT PRIOR AGREEMENT AND WRITTEN PERMISSION OF FORD PERFORMANCE PARTS

C257: Clutch Position Sensor

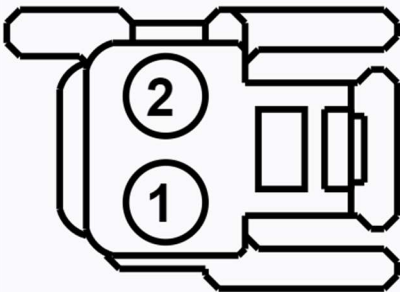

Circuit ID	AWG	Color	Function	Cavity
CE903	20	BU	CPP-BT	1
SGDI00A	20	BK	Ground Eyelet - Interior	2

C1217: Intercooler Coolant Pump

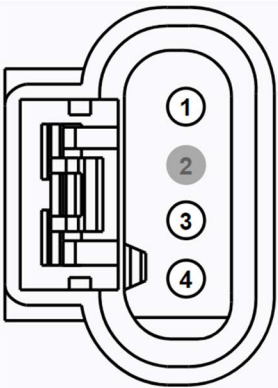

Circuit ID	AWG	Color	Function	Cavity
SGD200J	16	BK	Ground Eyelet - CHASSY	1
-	-	-		2
CE193	16	GY-BU	Charge Air Cooler Coolant Pump Control	3
CPC01	16	RD	ICPUMP	4

C2040: Accelerator Pedal Position Sensor (APPS)

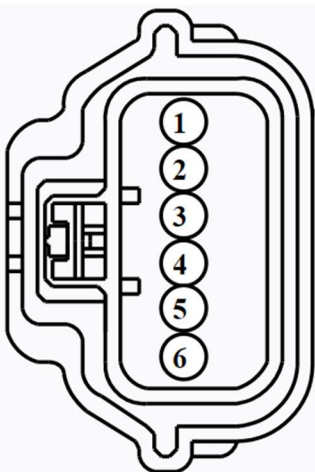

Circuit ID	AWG	Color	Function	Cavity
LE136	20	GN	APP1 VREF	1
VE701	20	YE	APP1 Signal	2
RE136	20	VT	APP1 RTN	3
RE137	20	YE	APP2 RTN	4
VE702	20	BU	APP2 Signal	5
LE137	20	BU	APP2 VREF	6

Factory Ford shop manuals are available from Helm Publications, 1-800-782-4356



FORD PERFORMANCE

# Installation Manual M-6017-M52SC 5.2L Control Pack

NO PART OF THIS DOCUMENT MAY BE REPRODUCED WITHOUT PRIOR AGREEMENT AND WRITTEN PERMISSION OF FORD PERFORMANCE PARTS

C251: Data Link Connector (DLC)

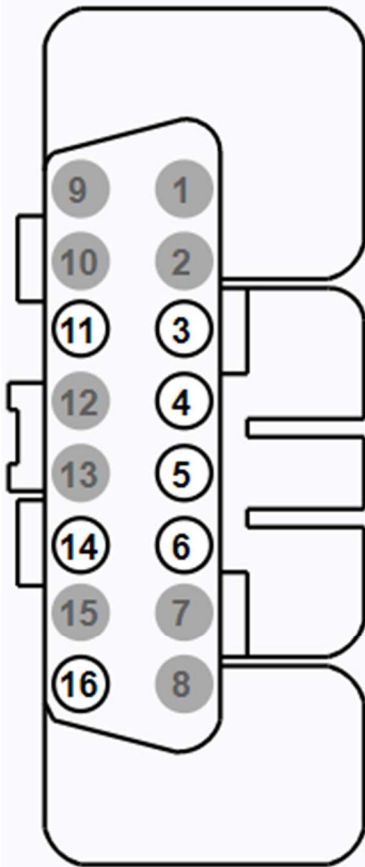

Circuit ID	AWG	Color	Function	Cavity
-	-	-	-	1
-	-	-	-	2
-	-	-	-	3
SGD100C	20	BK	Ground Eyelet - Interior	4
SGD100D	20	BK	Ground Eyelet - Interior	5
VDB04B	20	WH-BU	HS CAN (+)	6
-	-	-	-	7
-	-	-	-	8
-	-	-	-	9
-	-	-	-	10
-	-	-	-	11
-	-	-	-	12
-	-	-	-	13
VDB05B	20	WH	HS CAN (-)	14
-	-	-	-	15
DCF10C	20	RD	HAAT A	16
MIL01	18	BK	Malfunction Indicator Lamp (MIL)	1
DC02B	18	RD	MIL Power B+	2

C102A: Alternator

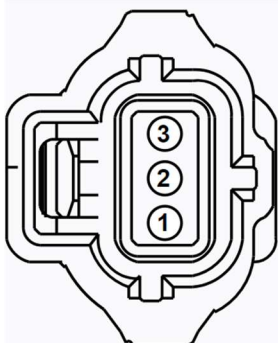

Circuit ID	AWG	Color	Function	Cavity
CDC15	20	VT	Alternator Load Input (GENLI)	1
CDC10	20	BU	Alternator Regulator Control (GENRC)	2
DCF10B	16	RD	HAAT A	3

Factory Ford shop manuals are available from Helm Publications, 1-800-782-4356



FORD PERFORMANCE

# Installation Manual M-6017-M52SC 5.2L Control Pack

NO PART OF THIS DOCUMENT MAY BE REPRODUCED WITHOUT PRIOR AGREEMENT AND WRITTEN PERMISSION OF FORD PERFORMANCE PARTS

C8: PATS Module

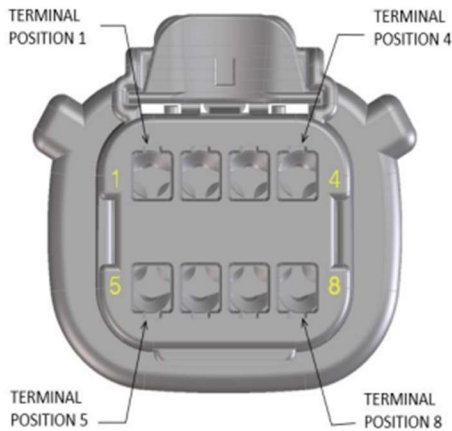

Circuit ID	AWG	Color	Function	Cavity
-	-	-	-	1
-	-	-	-	2
VDB04D	20	WT-BU	HSCAN (+)	3
VDB05D	20	WT-BU	HSCAN (-)	4
SGD100E	20	BK	GND	5
DCF08B	20	YE	12V Key on	6
-	-	-	-	7
DCF10D	20	RD	HAAT A	8

C128: Mass Air Flow (MAF) NOT USED ON 5.2L CONTROL PACK

Circuit ID	AWG	Color	Function	Cavity
-	-	-	-	1
VE740B	20	VT	IAT	2
DCF06B	20	GN	VPWR6	3
RE320	20	BU	MAF Return	4
VE807	20	YE	MAF (Freq)	5
-	-	-	-	6

Factory Ford shop manuals are available from Helm Publications, 1-800-782-4356



FORD PERFORMANCE

# Installation Manual M-6017-M52SC 5.2L Control Pack

NO PART OF THIS DOCUMENT MAY BE REPRODUCED WITHOUT PRIOR AGREEMENT AND WRITTEN PERMISSION OF FORD PERFORMANCE PARTS

C132: Ambient Air Temperature Sensor (AAT)

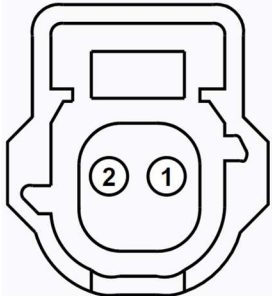

Circuit ID	AWG	Color	Function	Cavity
VH407	20	BU	AAT	1
RE406	20	BK	SIGRTN	2

C1743: Charge Air Coolant Temperature Sensor (CACCT)

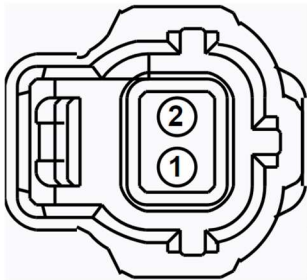

Circuit ID	AWG	Color	Function	Cavity
VE792	18	BU	CACCT	1
RE238	18	BK	SIGRTN	2

C1B: Inline from Main to Transmission Harness

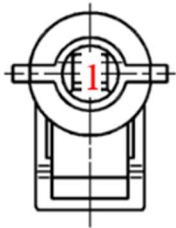

Circuit ID	AWG	Color	Function	Cavity
DCF08A	18	YE	Key On 12V/10A	1

Factory Ford shop manuals are available from Helm Publications, 1-800-782-4356



FORD PERFORMANCE

# Installation Manual

## M-6017-M52SC 5.2L Control Pack

NO PART OF THIS DOCUMENT MAY BE REPRODUCED WITHOUT PRIOR AGREEMENT AND WRITTEN PERMISSION OF FORD PERFORMANCE PARTS

C146: Inline from Main to Engine Harness

Circuit ID	AWG	Color	Function	Cavity/
DCF04	16	GY	VPWR4	1
-	-	-	-	2
RE238	18	BK	SIGRTN	3
VE792	18	GY	CACCT	4
-	-	-	-	5
-	-	-	-	6
CE193	16	GY-BU	Charge Air Cooler Coolant Pump Control	7
-	-	-	-	8
DCF06C	16	GN	VPWR6	9
-	-	-	-	10
-	-	-	-	11
SGD200E	16	BK	Ground Eyelet - CHASSY	12
-	-	-	-	13
-	-	-	-	14
-	-	-	-	15
DCF02	16	BU	VPWR2	16

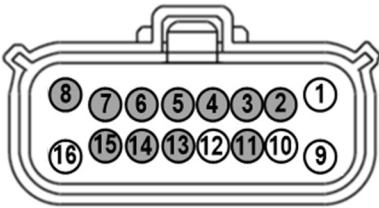

C160A: Inline to I/P Pigtail

Circuit ID	AWG	Color	Function	Cavity/
DCR04	12	GN	Fuel Pump Relay Out	1
CET43	20	GY	Shift UP	2
TS02	18	LIGHT BLUE	Starter Request (SMR)	3
CET42BLI	20	GN-VT	Shift Down	4
RT060	18	LIGHT GREEN	Ignition Relay Trigger (Toggle Switch)	5
RE472	20	BU	SIGRTN	6

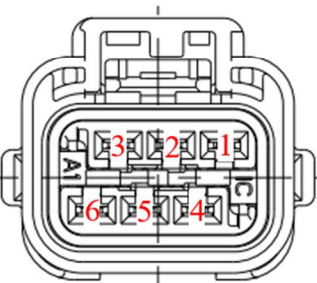

Factory Ford shop manuals are available from Helm Publications, 1-800-782-4356





FORD PERFORMANCE

# Installation Manual M-6017-M52SC 5.2L Control Pack

NO PART OF THIS DOCUMENT MAY BE REPRODUCED WITHOUT PRIOR AGREEMENT AND WRITTEN PERMISSION OF FORD PERFORMANCE PARTS

C175B: PCM Connector (Control Pack Main Harness)

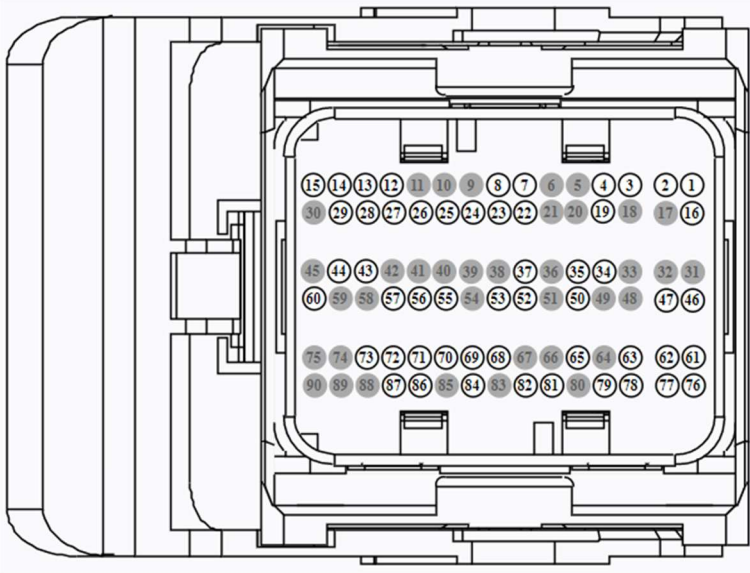

Circuit ID	AWG	Color	Function	Cavity
DCF01B	18	YE	VPWR1	1
DCF01C	18	YE	VPWR1	2
RT040	20	WH-YE	Fuel Pump Relay Trigger	3
RT020B	20	WH-BU	Fan Relay Trigger	4
DCF05B	20	RD	PCM_WAKE	7
VDB05A	20	WH	HS CAN (-)	12
DCF05C	20	RD	ISP_R	13
CDC10	20	BU	Alternator Regulator Control (GENRC)	15
DCF01D	18	YE	VPWR1	16
TS02	18	LIGHT BLUE	Starter Request (SMR)	22
VE740	20	VT	IAT	24
RE406	20	BK	SIGRTN	26
VDB04A	20	WH-BU	HS CAN (+)	27
RH433	20	BK	SIGRTN	28
MIL01	18	BK	Malfunction Indicator Lamp (MIL)	34

Factory Ford shop manuals are available from Helm Publications, 1-800-782-4356



FORD PERFORMANCE

# Installation Manual M-6017-M52SC 5.2L Control Pack

NO PART OF THIS DOCUMENT MAY BE REPRODUCED WITHOUT PRIOR AGREEMENT AND WRITTEN PERMISSION OF FORD PERFORMANCE PARTS

VE807	20	YE	MAF (Freq)	36
RT031	20	WH-OG	Starter Motor Control Sense (SMCS)	44
SGDPCMB1	18	BK	Ground Eyelet - Chassy	46
SGDPCMCI	18	BK	Ground Eyelet - Chassy	47
CDC15	20	VT	Alternator Load Input (GENLI)	50
CET43	20	GY	Shift UP	53
VE701	20	YE	APP1 Signal	56
RE320	20	BU	MAF Return	58
RT020C	20	WH-BU	Fan Relay Trigger	59
RT010	20	BN	PCMRC	60
SGDPCMD1	18	BK	Ground Eyelet - Chassy	61
SGDPCMB2	18	BK	Ground Eyelet - Chassy	62
CE903	20	BU	CPP-BT	65
VE702	20	BU	APP2 Signal	68
LE137	20	BU	APP2 VREF	71
RE137	20	YE	APP2 RTN	72
RE472	20	BU	SIGRTN	73
SGDPCMC2	18	BK	Ground Eyelet - Chassy	76
SGDPCMD2	18	BK	Ground Eyelet - Chassy	77
RT032	20	WH	Starter Moter Control (SMC)	78
VH407	20	BU	AAT	84
LE136	20	GN	APP1 VREF	86
RE136	20	VT	APP1 RTN	87

Factory Ford shop manuals are available from Helm Publications, 1-800-782-4356



FORD PERFORMANCE

# Installation Manual M-6017-M52SC 5.2L Control Pack

NO PART OF THIS DOCUMENT MAY BE REPRODUCED WITHOUT PRIOR AGREEMENT AND WRITTEN PERMISSION OF FORD PERFORMANCE PARTS

## 12.2 Control Pack Transmission Harness

C1571: UEGO (Universal Exhaust Gas Oxygen Sensor) RH (Bank 1)

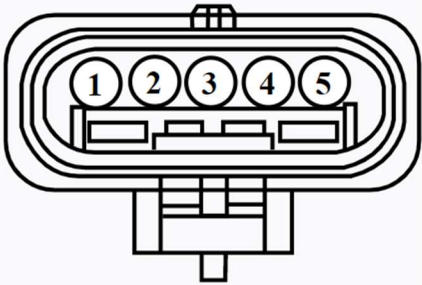

Circuit ID	AWG	Color	Function	Cavity
LE448	18	GY	UREF-11(RH)	1
VE826	18	YE	UO2SN-11(RH)	2
LE450	18	WT	UO2IP-11(RH)	3
CBK02A	18	RD	VPWR	4
CE235	18	BU	HTR-11(RH)	5

C1572: UEGO (Universal Exhaust Gas Oxygen Sensor) LH (Bank 2)

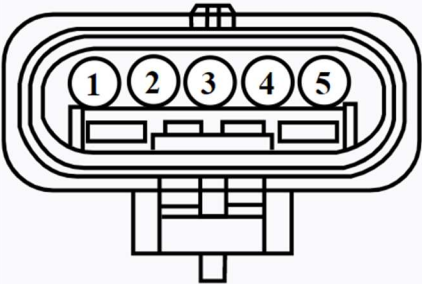

Circuit ID	AWG	Color	Function	Cavity
LE449	18	VT	UREF-21(LH)	1
VE827	18	OG	UO2SN-21(LH)	2
LE451	18	BR	UO2IP-21(LH)	3
CBK02B	18	RD	VPWR	4
CE236	18	LT BU	HTR-21(LH)	5

C141: HO2S (Downstream Catalyst Monitor Oxygen Sensor) RH (Bank 1) NOT USED ON 5.2L CONTROL PACK

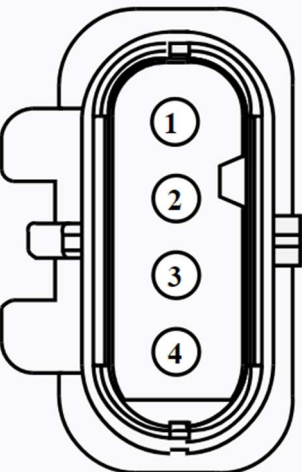

Circuit ID	AWG	Color	Function	Cavity
CE233	18	WT	HTR-12(RH)	1
CBK02C	18	RD	VPWR	2
RE731	18	BK	SIGRTN-12(RH)	3
VE731	18	YE	HO2S-12(RH)	4

Factory Ford shop manuals are available from Helm Publications, 1-800-782-4356



FORD PERFORMANCE

# Installation Manual M-6017-M52SC 5.2L Control Pack

NO PART OF THIS DOCUMENT MAY BE REPRODUCED WITHOUT PRIOR AGREEMENT AND WRITTEN PERMISSION OF FORD PERFORMANCE PARTS

C142: H02S (Downstream Catalyst Monitor Oxygen Sensor) LH (Bank 2) NOT USED ON 5.2L CONTROL PACK

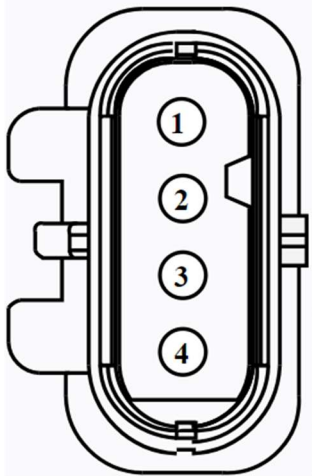

Circuit ID	AWG	Color	Function	Cavity
CE234	18	DK BU	HTR-22(LH)	1
CBK02D	18	RD	VPWR	2
RE733	18	LT GN	SIGRTN-22(LH)	3
VE733	18	WT	H02S-22(LH)	4

C1A: Inline from Trans Harness to Control Pack Main Harness

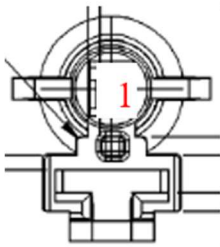

Circuit ID	AWG	Color	Function	Cavity
CBK02C	18	RD	VPWR	1

Factory Ford shop manuals are available from Helm Publications, 1-800-782-4356



FORD PERFORMANCE

# Installation Manual M-6017-M52SC 5.2L Control Pack

NO PART OF THIS DOCUMENT MAY BE REPRODUCED WITHOUT PRIOR AGREEMENT AND WRITTEN PERMISSION OF FORD PERFORMANCE PARTS

C90: PCM Connector (Transmission Harness)

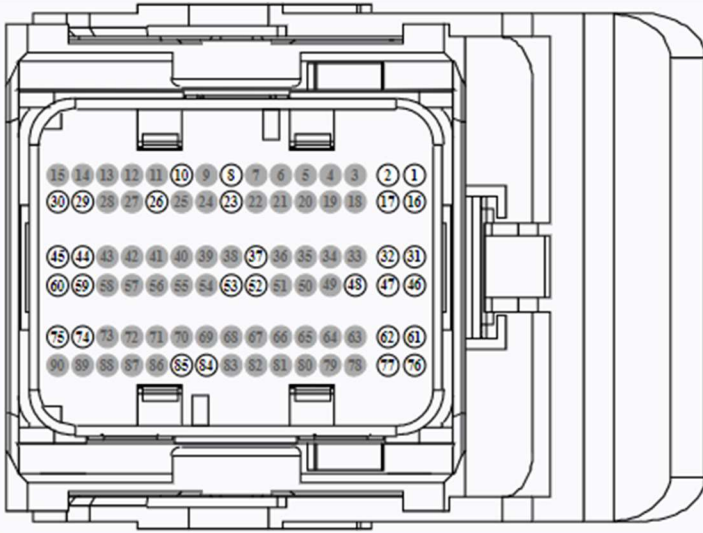

Circuit ID	AWG	Color	Function	Cavity
VE731	18	YE	H02S-12(RH)	10
CE234	18	DK BU	HTR-22(LH)	16
VE733	18	WT	H02S-22(LH)	26
LE450	18	WT	U02IP-11(RH)	29
LE451	18	BR	U02IP-21(LH)	30
LE448	18	GY	UREF-11(RH)	44
LE449	18	VT	UREF-21(LH)	45
CE236	18	LT BU	HTR-21(LH)	46
VE826	18	YE	U02SN-11(RH)	59
VE827	18	OG	U02SN-21(LH)	60
CE235	18	BU	HTR-11(RH)	76
CE233	18	WT	HTR-12(RH)	77
RE731	18	BK	SIGRTN-12(RH)	84
RE733	18	LT GN	SIGRTN-22(LH)	85

Factory Ford shop manuals are available from Helm Publications, 1-800-782-4356



FORD PERFORMANCE

# Installation Manual M-6017-M52SC 5.2L Control Pack

NO PART OF THIS DOCUMENT MAY BE REPRODUCED WITHOUT PRIOR AGREEMENT AND WRITTEN PERMISSION OF FORD PERFORMANCE PARTS

## 12.3 Engine Harness

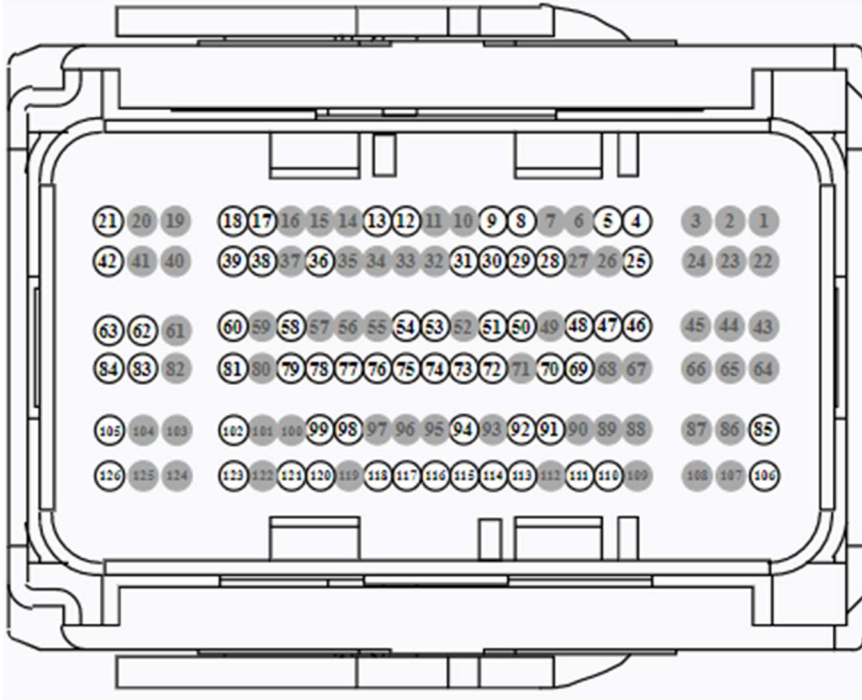

Pin	Circuit	Gauge	Circuit Function
4	CE421 (VT)	18	CTRL MOD. - POWERTRAIN # VARIABLE CAMSHAFT TIMING VALVE 1 (VCT1)
5	RE238 (BU-BN)	18	CTRL MOD. - POWERTRAIN # FUEL RAIL PRESSURE SENSOR -
8	VE712 (BU-GY)	20	SENSOR - CYLINDER HEAD TEMPERATURE (CHT)
9	RE323 (WH-BN)	18	CTRL MOD. - POWERTRAIN # KNOCK SENSOR 1ST BANK 1ST OR UNIQUE (KS1N) [KSL1-]
12	VE818 (BN)	20	SENSOR - THROTTLE POSITION # NEGATIVE SLOPE (TP1-NS)
13	RE320 (BU)	18	CTRL MOD. - POWERTRAIN # SUPERCHARGER INLET PRESSURE (SIGRTN)
17	CE264 (YE-VT)	20	CTRL MOD. - POWERTRAIN # FUEL INJECTOR CONTROL FEED 3
18	CE267 (BU-GY)	20	CTRL MOD. - POWERTRAIN # FUEL INJECTOR CONTROL FEED 6
21	CE303 (WH-VT)	18	CTRL MOD. - POWERTRAIN # IGNITION COIL ON PLUG ASSEMBLY 1 (COP-A)
25	CE442 (YE-GY)	18	CTRL MOD. - POWERTRAIN # VARIABLE CAMSHAFT TIMING VALVE 3
28	VE792 (YE-BU)	18	SENSOR - CHARGE AIR COOLER COOLANT TEMPERATURE (CACCT) +
29	VE716 (YE)	18	SENSOR - ENGINE COOLANT TEMPERATURE (ECT)
30	VE801 (VT-OG)	18	SENSOR - KNOCK 1ST BANK 1ST OR UNIQUE (KS1P) [KSL1+]
31	VE728 (GN)	18	SENSOR - FUEL RAIL TEMPERATURE (FRT)
36	CE263 (BU-GN)	20	CTRL MOD. - POWERTRAIN # FUEL INJECTOR CONTROL FEED 2

Factory Ford shop manuals are available from Helm Publications, 1-800-782-4356



FORD PERFORMANCE

# Installation Manual M-6017-M52SC 5.2L Control Pack

NO PART OF THIS DOCUMENT MAY BE REPRODUCED WITHOUT PRIOR AGREEMENT AND WRITTEN PERMISSION OF

Pin	Circuit	Gauge	Circuit Function
			FORD PERFORMANCE PARTS
38	CE266 (VT-GN)	20	CTRL MOD. – POWERTRAIN # FUEL INJECTOR CONTROL FEED 5
39	CE262 (GN)	20	CTRL MOD. – POWERTRAIN # FUEL INJECTOR CONTROL FEED 1
42	CE308 (VT-BN)	18	CTRL MOD. – POWERTRAIN # IGNITION COIL ON PLUG ASSEMBLY 6 (COP-F)
46	CE113 (WH-BN)	18	CTRL MOD. – POWERTRAIN # CANISTER PURGE VALVE (CANP)
47	RE143 (VT)	20	CTRL MOD. – POWERTRAIN # CAMSHAFT SENSOR 1 -
48	CBK01 (BU)	20	FUSE – 1 OR CIRCUIT BREAKER (VPWR F)
50	VE803 (BU-GN)	18	SENSOR – SUPERCHARGER INTAKE PRESSURE (SCIP)
51	VE802 (BN-BU)	18	SENSOR – KNOCK 2 <sup>ND</sup> BANK 1 <sup>ST</sup> (KS2P) [KSL2+]
53	VE828 (YE-OG)	18	SENSOR – KNOCK 1 <sup>ST</sup> BANK 2 <sup>ND</sup>
54	VE706 (GN-VT)	18	SENSOR – CAMSHAFT POSITION BANK 1 IN+EX / IN (CMP1) [CID-H] (CID1) +
58	VE829 (GN-BU)	18	SENSOR – KNOCK 2 <sup>ND</sup> BANK 2 <sup>ND</sup>
60	CH307 (GY-BU)	18	CTRL MOD. – POWERTRAIN # HEATED PUMP CONTROL RELAY (HPCR)
62	CE307 (WH-BN)	18	CTRL MOD. – POWERTRAIN # IGNITION COIL ON PLUG ASSEMBLY 5 (COP-E)
63	CE305 (BU-OG)	18	CTRL MOD. – POWERTRAIN # IGNITION COIL ON PLUG ASSEMBLY 3 (COP-C)
69	CMC24 (GY)	18	SWITCH – OIL PRESSURE
70	VE761 (BN-BU)	18	SENSOR – FUEL LOW PRESSURE (FLPS)
72	RE324 (BN-GN)	18	CTRL MOD. – POWERTRAIN # KNOCK SENSOR 2 <sup>ND</sup> BANK 1 <sup>ST</sup> (KS2N) [KSL2-]
73	VE763 (YE)	18	SENSOR – CRANKCASE VENTILATION MONITOR (CVM)
74	RE344 (GN)	18	CTRL MOD. – POWERTRAIN # KNOCK SENSOR 1 <sup>ST</sup> BANK 2 <sup>ND</sup>
75	VE738 (YE-BU)	18	SENSOR – CAMSHAFT POSITION BANK 2 EX
76	VE736 (WH-GN)	18	SENSOR – CAMSHAFT POSITION BANK 1 EX
77	VE707 (GN-VT)	18	SENSOR – CAMSHAFT POSITION BANK 2 IN+EX / IN (CMP2) [CID-H] (CID2) +
78	LE135 (VT-GN)	18	CTRL MOD. – POWERTRAIN # CRANKSHAFT POSITION SENSOR (CKP) +
79	RE345 (VT-GY)	18	CTRL MOD. – POWERTRAIN # KNOCK SENSOR 2 <sup>ND</sup> BANK 2 <sup>ND</sup>
81	CE265 (WH)	20	CTRL MOD. – POWERTRAIN # FUEL INJECTOR CONTROL FEED 4
83	CE309 (YE-GY)	18	CTRL MOD. – POWERTRAIN # IGNITION COIL ON PLUG ASSEMBLY 7 (COP-G)
84	CE306 (GN-VT)	18	CTRL MOD. – POWERTRAIN # IGNITION COIL ON PLUG ASSEMBLY 4 (COP-D)
85	CE426 (BU-GN)	18	CTRL MOD. – POWERTRAIN # THROTTLE ACTUATOR CONTROL MOTOR (TACM-)
91	RE144 (BN)	20	CTRL MOD. – POWERTRAIN # CAMSHAFT SENSOR 2 -
92	RE402 (GN)	18	CTRL MOD. – POWERTRAIN # SIGNAL RETURN ENGINE #2
94	LE329 (BU)	18	CTRL MOD. – POWERTRAIN # MANIFOLD PRESSURE SENSOR (MAP) +
98	CE193 (GY-OG)	18	CTRL MOD. – POWERTRAIN # CHARGE AIR COOLER COOLANT PUMP CONTROL (CACPC)

Factory Ford shop manuals are available from Helm Publications, 1-800-782-4356



FORD PERFORMANCE

# Installation Manual M-6017-M52SC 5.2L Control Pack

NO PART OF THIS DOCUMENT MAY BE REPRODUCED WITHOUT PRIOR AGREEMENT AND WRITTEN PERMISSION OF

Pin	Circuit	Gauge	Circuit Function
			FORD PERFORMANCE PARTS
99	RE138 (BU-GN)	20	CTRL MOD. - POWERTRAIN # CYLINDER HEAD TEMPERATURE SENSOR
102	CE422 (WH-OG)	18	CTRL MOD. - POWERTRAIN # VARIABLE CAMSHAFT TIMING VALVE 2 (VCT2)
105	CE310 (BU-BN)	18	CTRL MOD. - POWERTRAIN # IGNITION COIL ON PLUG ASSEMBLY 8 (COP-H)
106	CE412 (YE-VT)	18	CTRL MOD. - POWERTRAIN # THROTTLE ACTUATOR CONTROL MOTOR (TACM+)
110	CE269 (GY-VT)	20	CTRL MOD. - POWERTRAIN # FUEL INJECTOR CONTROL FEED 8
111	CE443 (BN-VT)	18	CTRL MOD. - POWERTRAIN # VARIABLE CAMSHAFT TIMING VALVE 4
113	RE135 (GN-WH)	18	CTRL MOD. - POWERTRAIN # CRANKSHAFT POSITION SENSOR (CKPN) -
114	RE134 (BU-OG)	20	CTRL MOD. - POWERTRAIN # ELECTRONIC THROTTLE CONTROL (ETCRTN)
115	LE238 (GY)	18	CTRL MOD. - POWERTRAIN # FUEL RAIL PRESSURE SENSOR +
116	LE423 (GN-VT)	18	CTRL MOD. - POWERTRAIN # VOLTAGE REFERENCE ENGINE (VREF) (E-VREF) (VREF1)
117	LE134 (YE)	20	CTRL MOD. - POWERTRAIN # ELECTRONIC THROTTLE CONTROL (ETCREF)
118	LE111 (VT-GN)	18	CTRL MOD. - POWERTRAIN # BUFFERED POWER SUPPLY SENSORS (VBPWR)
120	VE711 (GN-VT)	18	SENSOR - CRANKSHAFT POSITION (CKPP) +
121	RE468 (WH-VT)	18	SENSOR - TURBOCHARGER BOOST PRESSURE/CHARGE AIR COOLER TEMPERATURE SENSOR
123	CE268 (BN-YE)	20	CTRL MOD. - POWERTRAIN # FUEL INJECTOR CONTROL FEED 7
126	CE304 (YE-BU)	18	CTRL MOD. - POWERTRAIN # IGNITION COIL ON PLUG ASSEMBLY 2 (COP-B)

Factory Ford shop manuals are available from Helm Publications, 1-800-782-4356





FORD PERFORMANCE

# Installation Manual M-6017-M52SC 5.2L Control Pack

NO PART OF THIS DOCUMENT MAY BE REPRODUCED WITHOUT PRIOR AGREEMENT AND WRITTEN PERMISSION OF FORD PERFORMANCE PARTS

## 13.0 - CAN Message Definition

**NOTE:** There are two access points for use of HSCAN. See blunt cut circuits (Item J) and Connector C8 (Item G).

Parameter	PCM Units	Rate (ms)	Rate (Hz)	PCM->CAN Conversion	Range	Resolution	Num Bits	Offset	Notes
ENGINE_SPEED	RPM	10	100	None	0-16383	1	14	0	
ENGINE_SPEED_HZ	Hz	10	100	rpm/60*100	0-163.83	0.01	14	0	0-9829 RPM
AF0	A/F	10	100	((lambda * stoic afr) - 7.0) * 100	7-27.47	0.01	11	7	Lambda converted to A/F based on Stoic A/F value
AF1	A/F	10	100	((lambda * stoic afr) - 7.0) * 100	7-27.47	0.01	11	7	Lambda converted to A/F based on Stoic A/F value
Fuel_Pressure	Kpa	10	100	psi * 6.89476	0-511	1	9	0	Rail on FFV/Lift pump on DFFI
DI_Pressure	Kpa	10	100	psi * 6.89476	0-32768	1	15	0	Only on DI/DFFI engines
BOOST	Kpa	10	100	psi * 6.89476	0-511	1	9	0	Only On boosted engines, positive pressure only
VSPD	MPH	20	50	mph * 1.60934	0-409.5	0.1	12	0	
MAN_VAC	InHg	20	50	((InHg * 3.38639) + 105) * 10	-105-409.5	0.1	12	-105	Gauge pressure
ECT	degF	100	10	(degF - 32) * 5/9	-40-213	1	8	-40	214=degraded, 215=Failed
EOT	degF	100	10	(degF - 32) * 5/9	-40-213	1	8	-40	214=degraded, 215=Failed
EOP	Kpa	100	10		0-1023	1	10	0	
VBAT	volts	100	10	vbat * 100	0-20.47	0.01	11	0	
Codes_Count	-	100	10		0-255	1	8	0	
TOT	degF	100	10	(degF - 32) * 5/9	-40-213	1	8	-40	214=degraded, 215=Failed
Gear	-	100	10		0-15	1	4	0	
Shifter_Position	-	100	10		0-15	1	4	0	

Message ID	Transmitter	Rate (Hz)	Rate (ms)	Bit Number																																																																	
				0	1	2	3	4	5	6	7	8	9	10	11	12	13	14	15	16	17	18	19	20	21	22	23	24	25	26	27	28	29	30	31	32	33	34	35	36	37	38	39	40	41	42	43	44	45	46	47	48	49	50	51	52	53	54	55	56	57	58	59	60	61	62	63		
0x270	PCM	100	10	Res	ENGINE_SPEED								R	ENGINE_SPEED_HZ								AF0								AF1								MAN_VAC								Res	DI_PRESSURE																						
0x274	PCM	50	20	Reserved								BOOST								AF0								AF1								Fuel_Pressure								Reserved																									
0x275	PCM	50	20	VSPD								reserved								reserved								reserved								reserved								reserved																									
0x278	PCM	100	100	ECT								EOT								TOT								EOP								Res	Shifter_Position								CODES_COUNT								VBAT								R	Gear							

Factory Ford shop manuals are available from Helm Publications, 1-800-782-4356





FORD PERFORMANCE

# Installation Manual

## M-6017-M52SC 5.2L Control Pack

NO PART OF THIS DOCUMENT MAY BE REPRODUCED WITHOUT PRIOR AGREEMENT AND WRITTEN PERMISSION OF FORD PERFORMANCE PARTS

### 14.2 Manual Transmission Harness

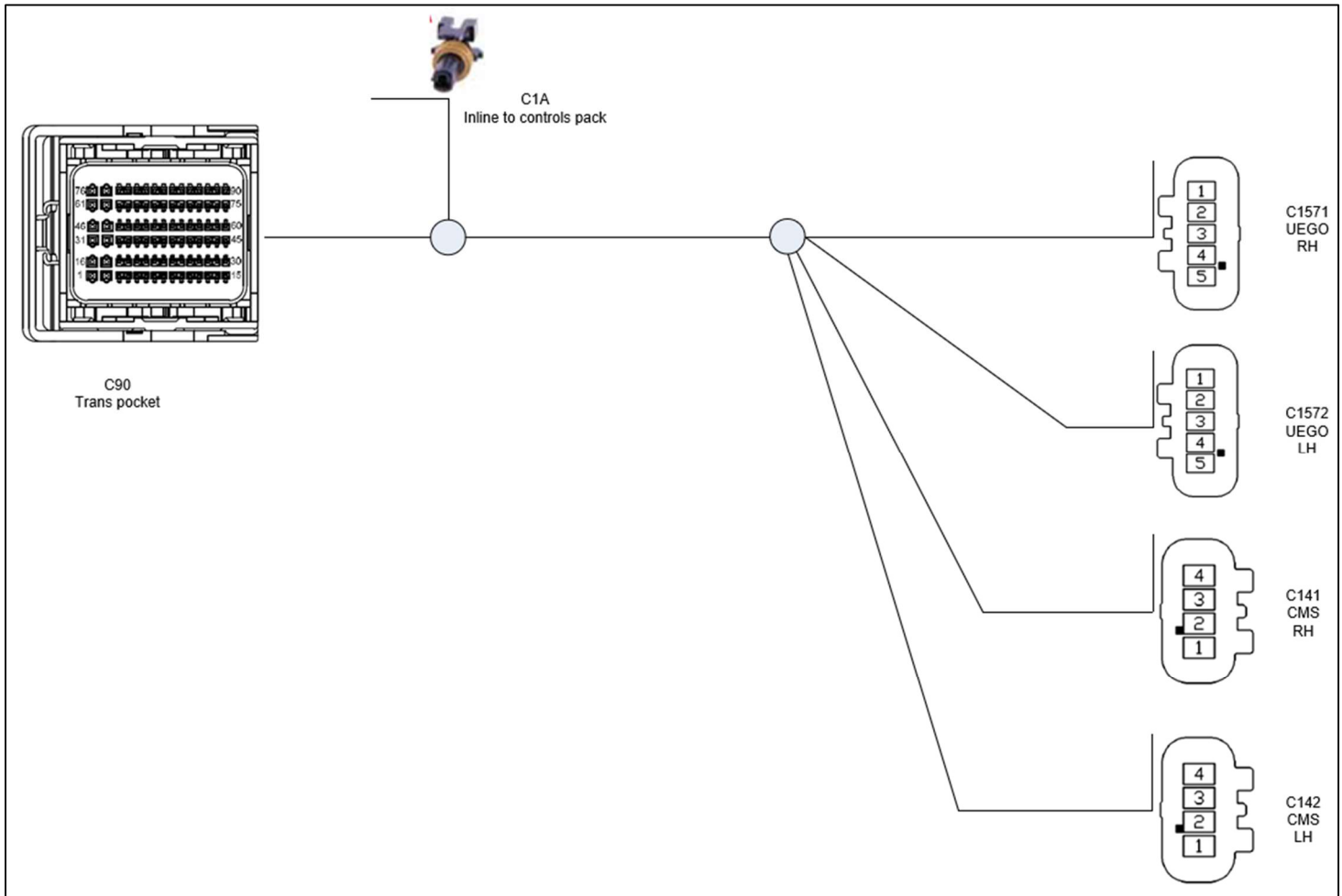

Factory Ford shop manuals are available from Helm Publications, 1-800-782-4356