

Ford Performance Ranger Off-Road Bumper

M-17757-R1F

Notice to Installer



Software Program Required. Dealer Tools Required



WARNING

WARNING: Failure to follow these instructions could result in personal injury or death:

- **When this bumper is fitted, and again if this bumper is removed, a software update must be performed by a Ford dealer or qualified technician. Failure to perform the software update will affect airbag deployment and may affect other safety systems.**
- Installation instructions must be followed to ensure correct fitment to the vehicle and proper operation of the accessory.
- This product and its installation must not be modified.
- No accessory or fitment shall extend beyond the front of the vehicle.
- This product was specifically designed for this vehicle. Do not use in any other vehicle.

M2DA-25729-BB

Installer Delivery Checklist

- 1) Review this Checklist with Vehicle Owner
 - a. Front Park Aid is not Bumper Compatible. There are no provisions to install park sensors
 - b. Radar Speed Control is not Bumper Compatible. There are no provisions to install radar
 - c. The Original Factory Bumper should be returned to customer after installation

PRIOR TO INSTALLATION READ THESE INSTRUCTION COMPETELY
For questions, Call the FORD PERFORMANCE Techline 1-800-367-3788





Please visit <https://www.performanceparts.ford.com> for warranty information
Ford Factory Shop Manual purchase options www.motorcraftservice.com

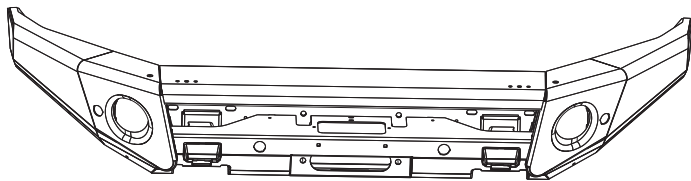
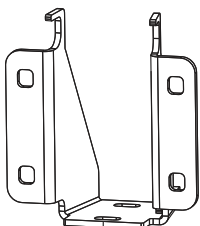

EN INSTALLATION INSTRUCTION
OFF ROAD BUMPER

© Copyright Ford 2022
Printed Copies are uncontrolled
Expert Fitment Required
Subject to alteration without notice

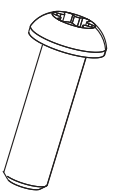
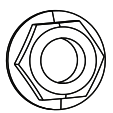
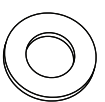
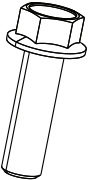
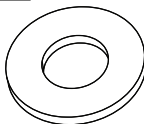
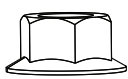
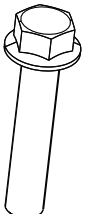
RANGER 2019 

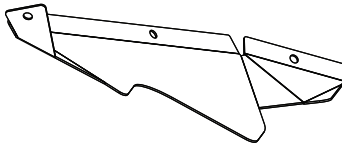
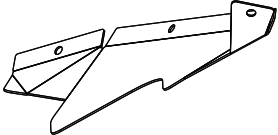
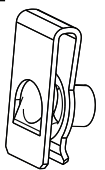
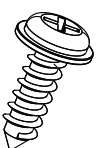
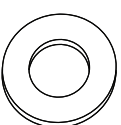
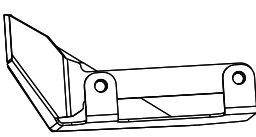
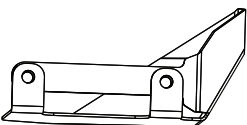
A 	B  X2	C  X2			
D  X18	E  X8	F  X8	J  X8	K  X6	L  X8
O  X4	P  X6	Q 	R 		
T  X6	U  X2	V  X4	W 	X 	



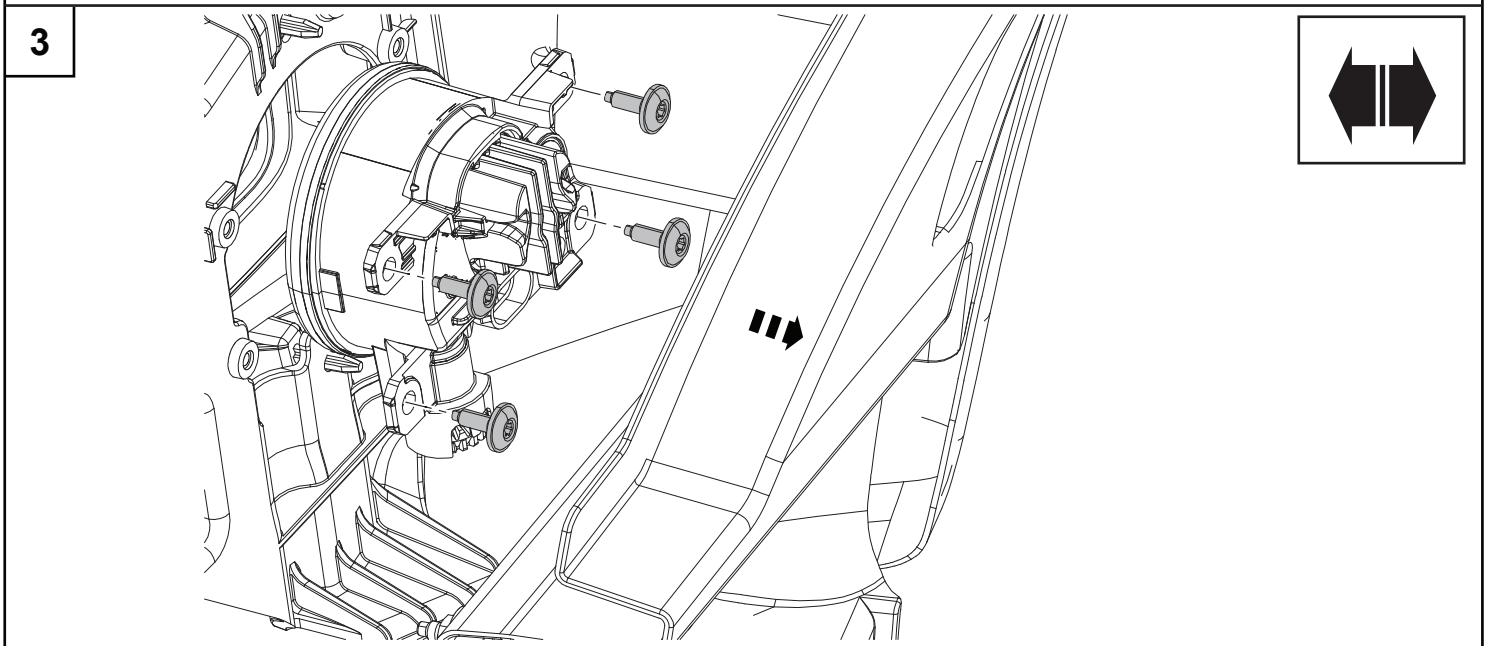
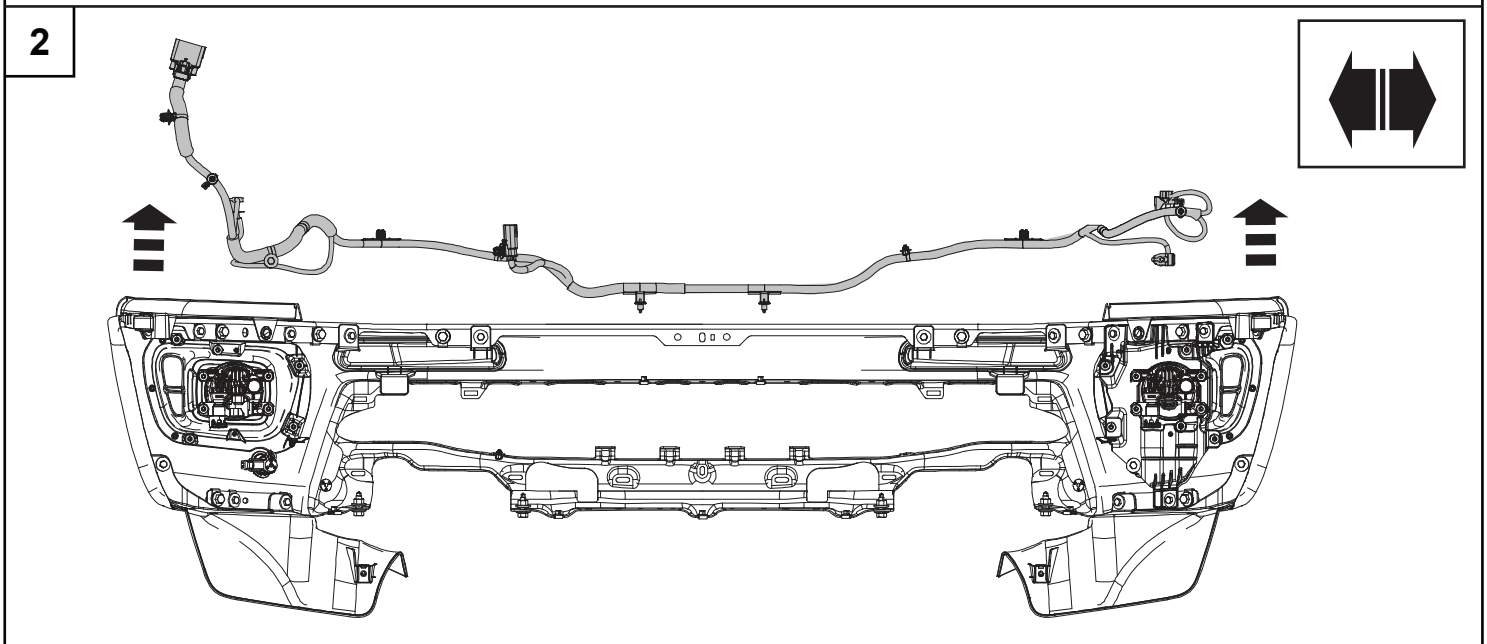
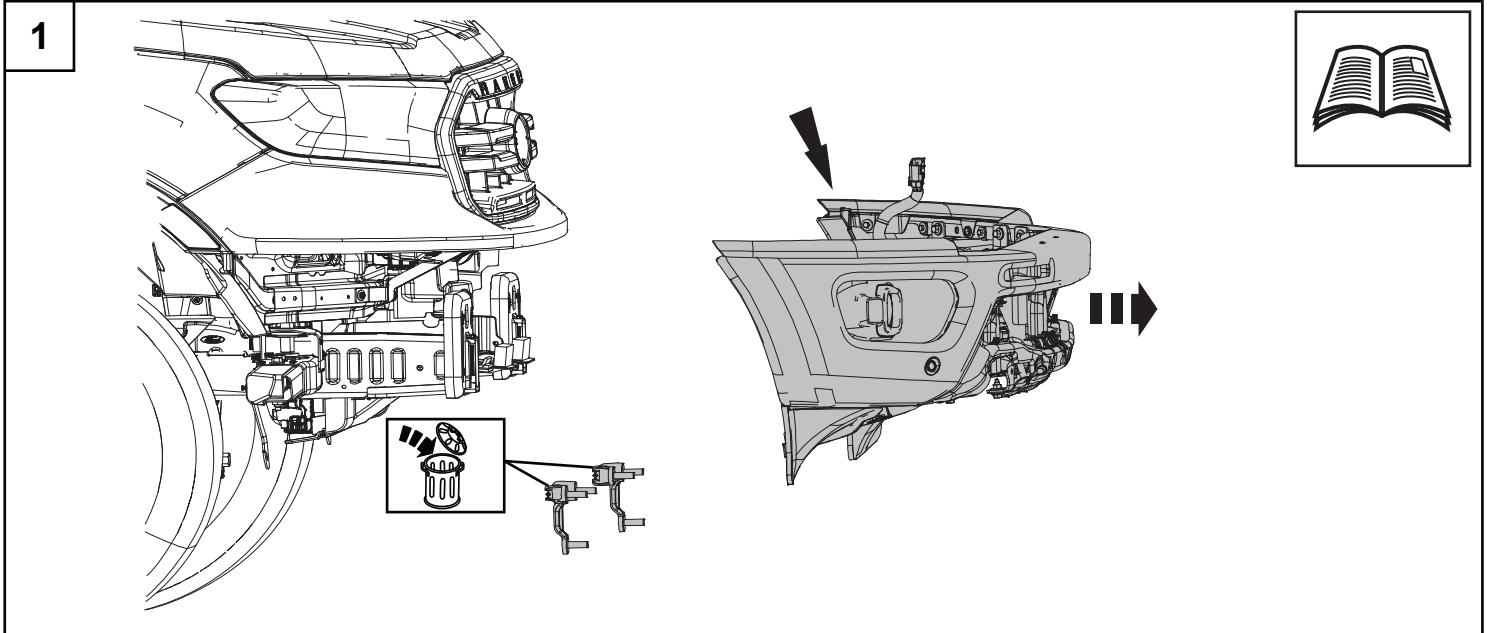

4

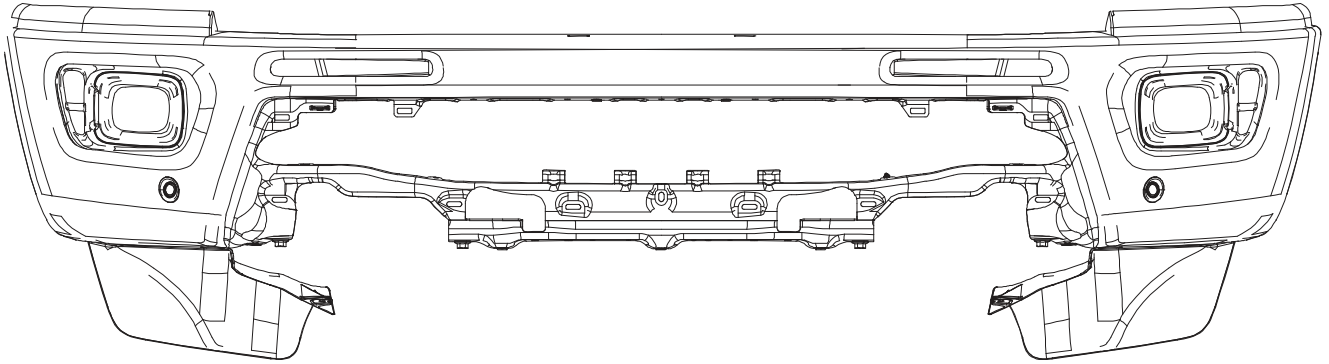
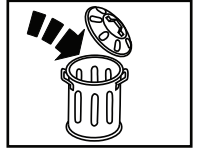

5

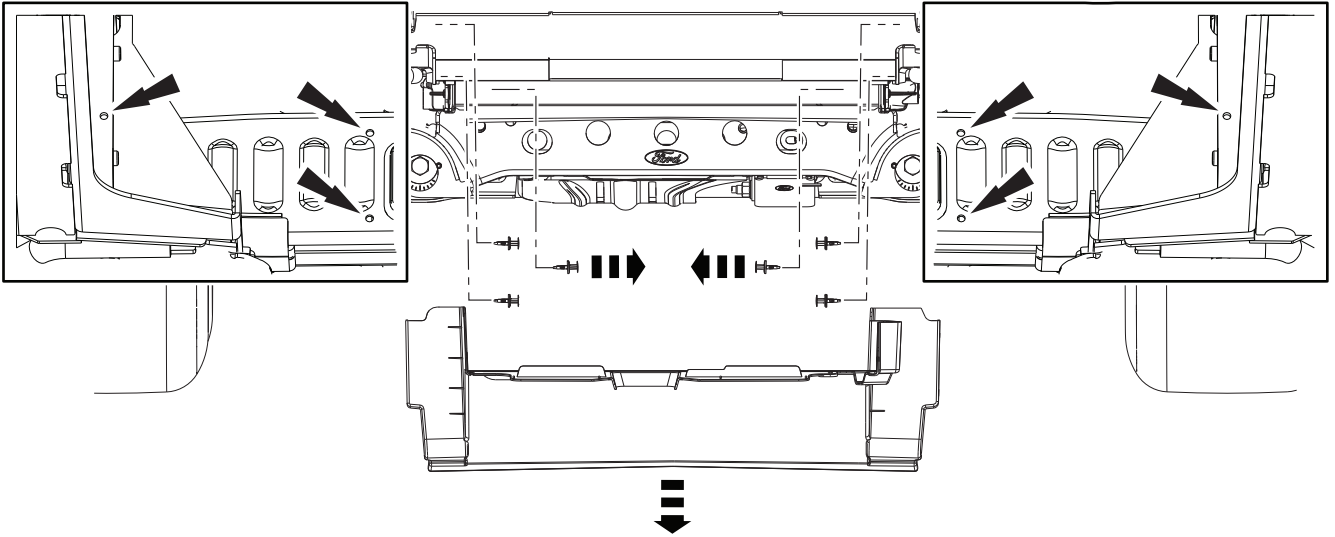

6

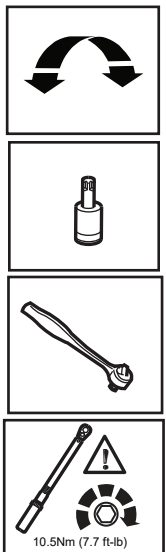
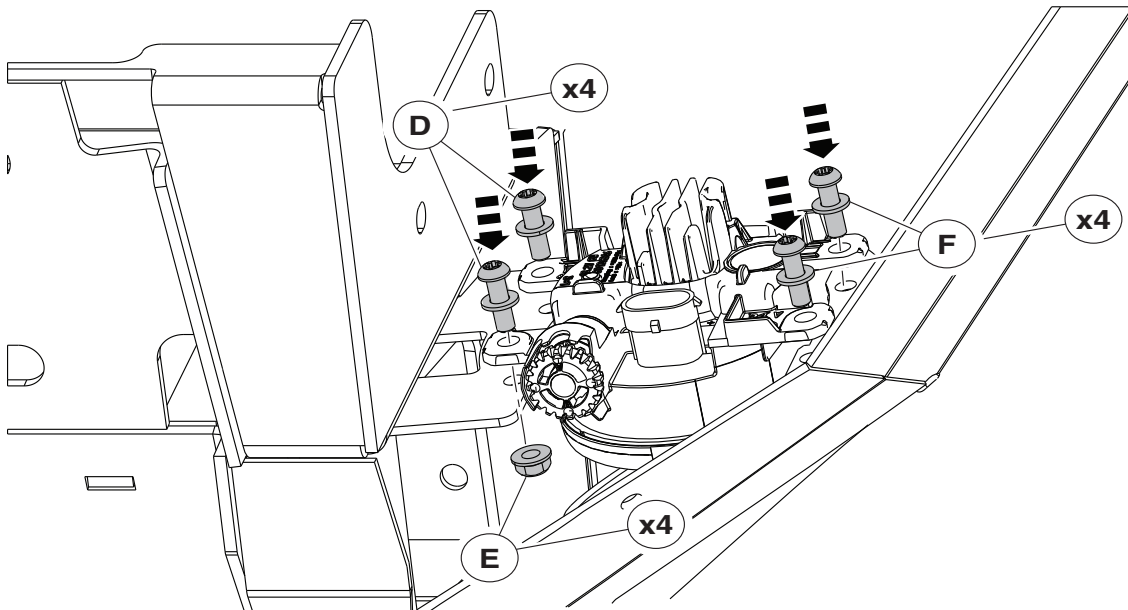

7

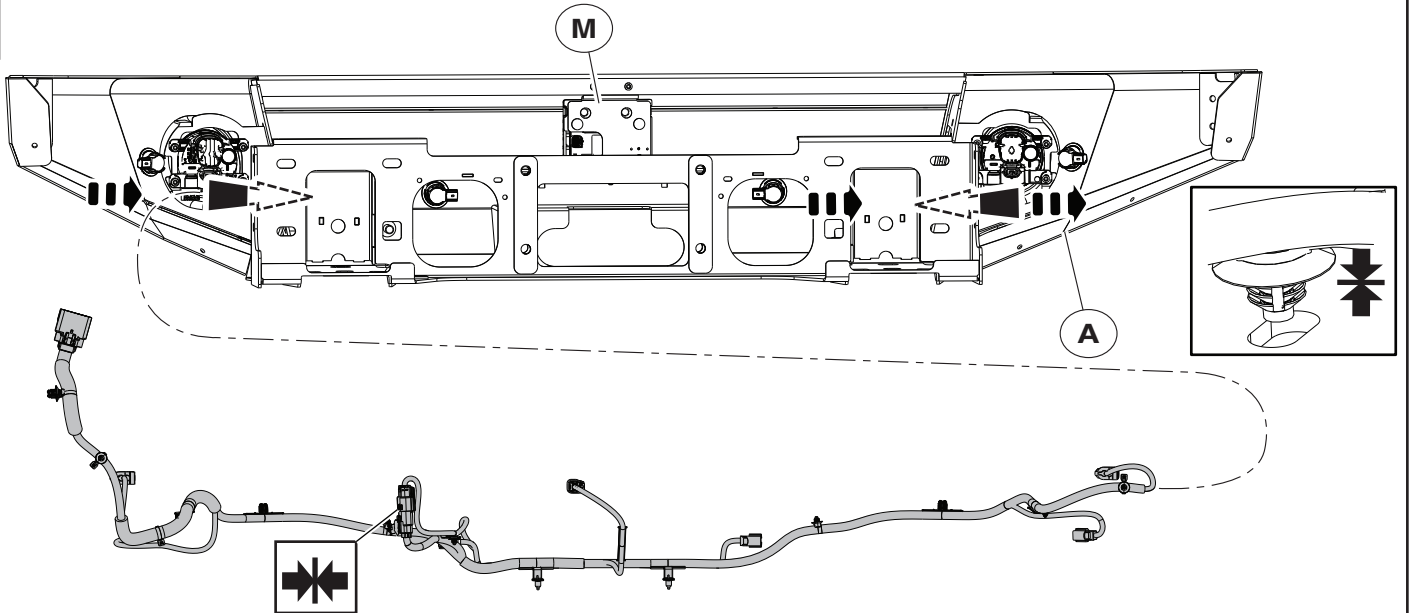

8

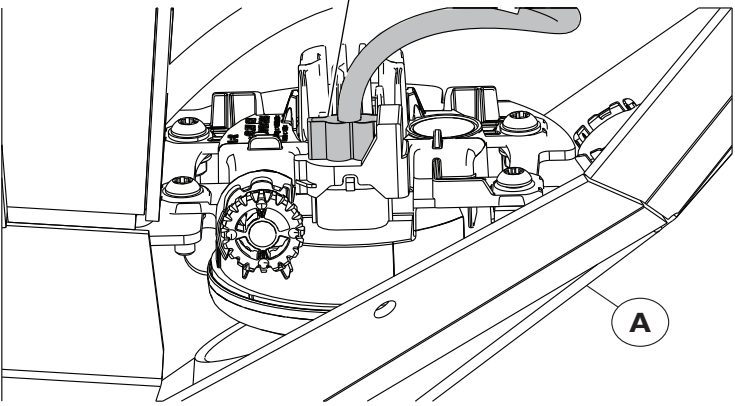
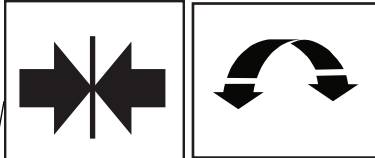

9

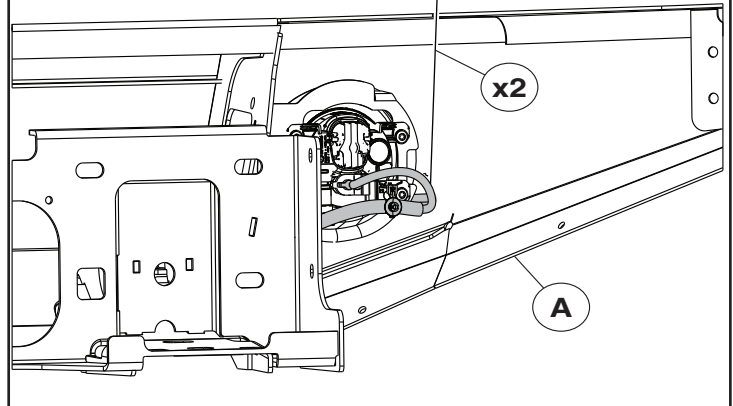
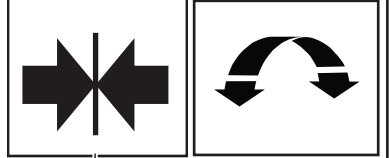

10

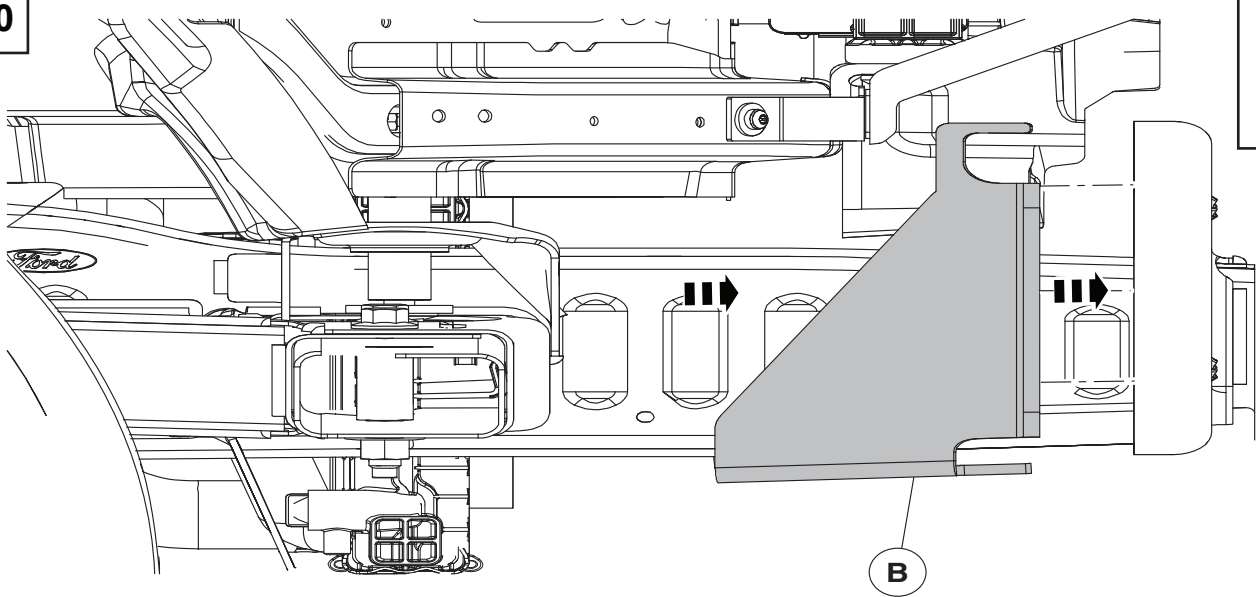
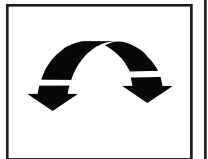

11

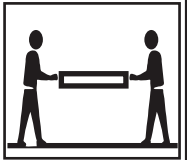
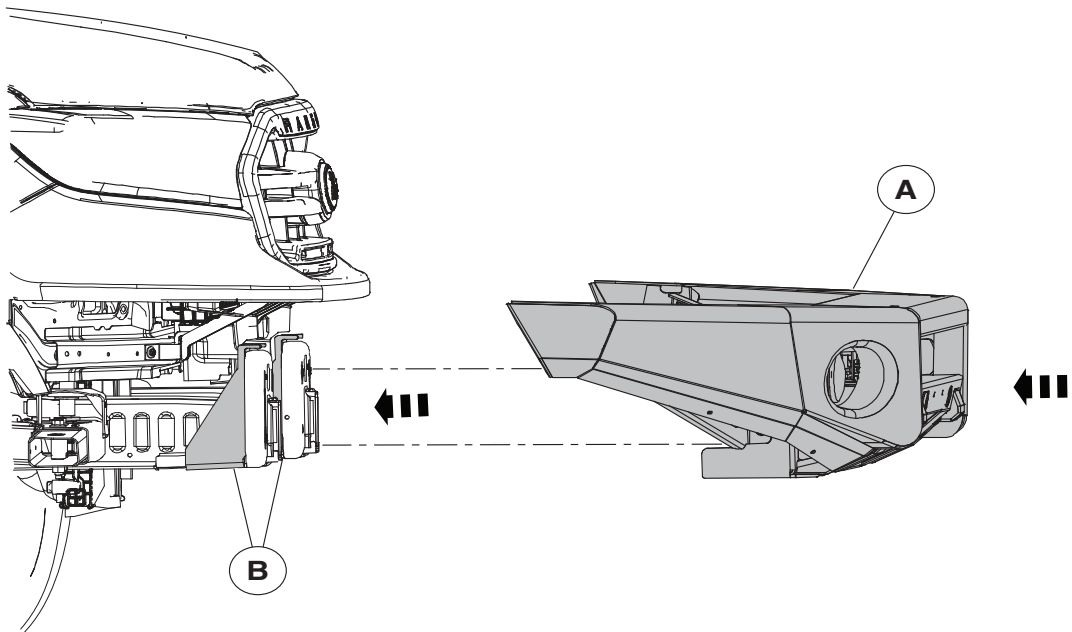

12

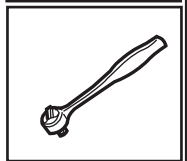
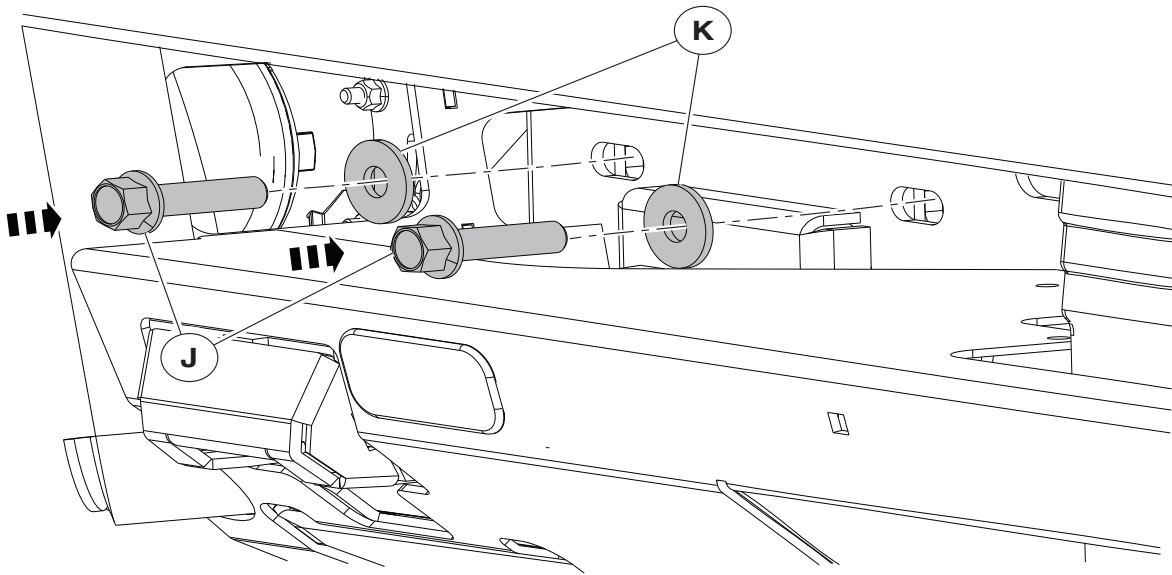

13

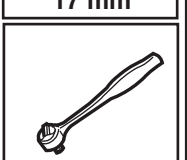
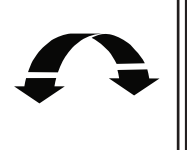
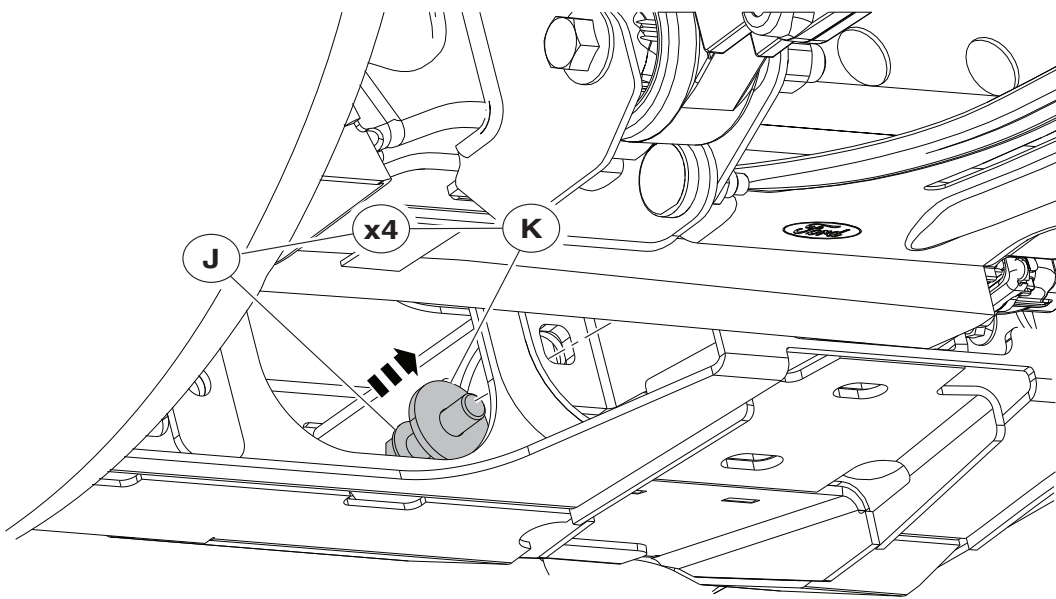

14

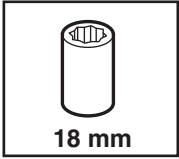
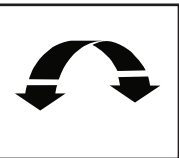
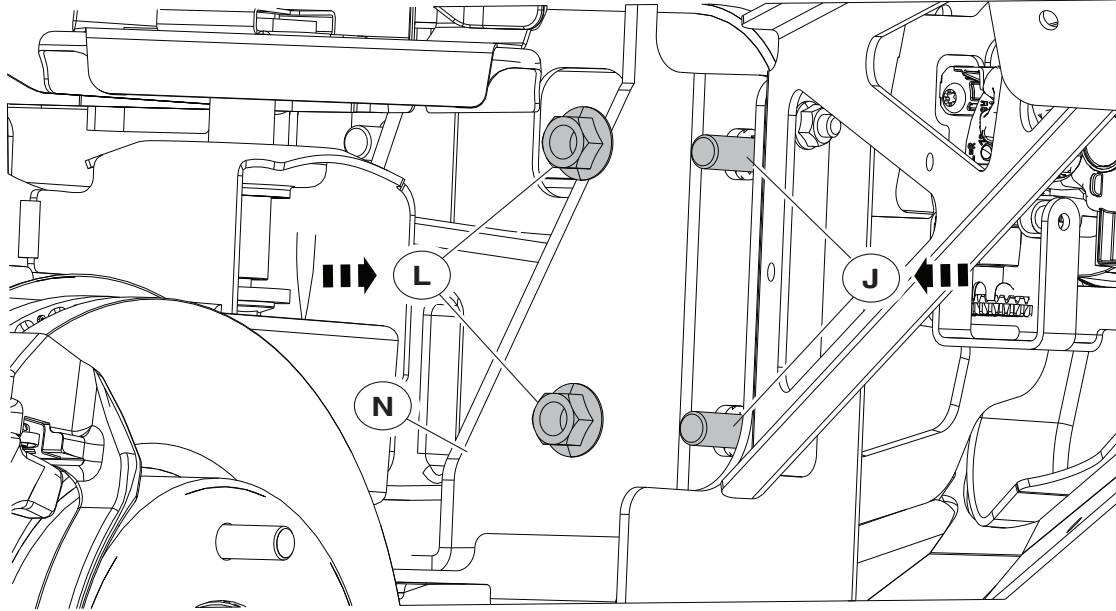

15

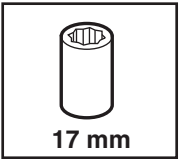
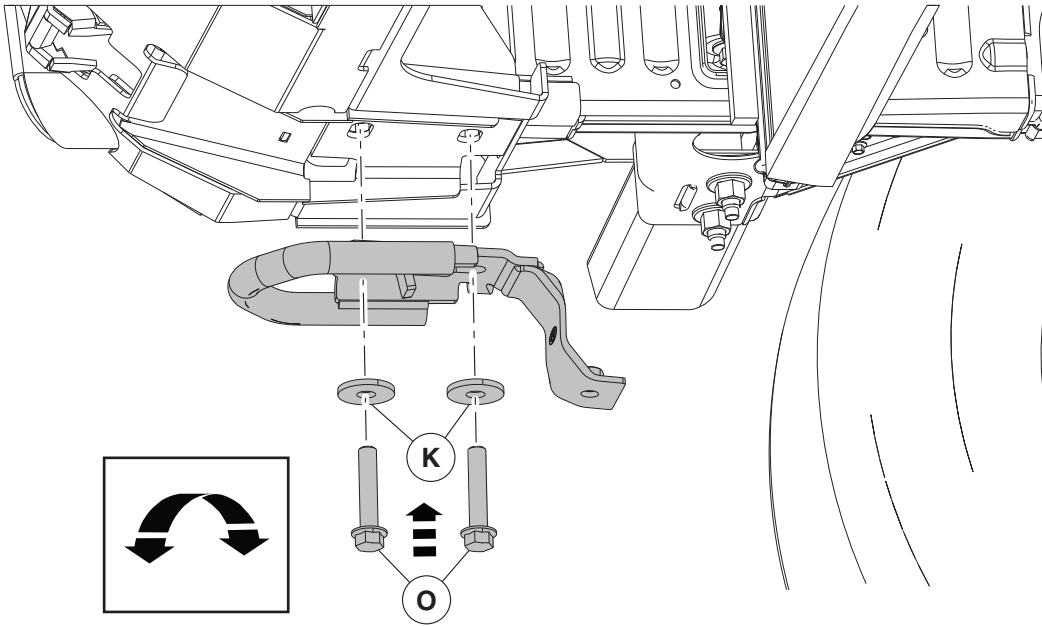

16

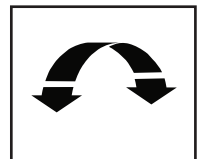
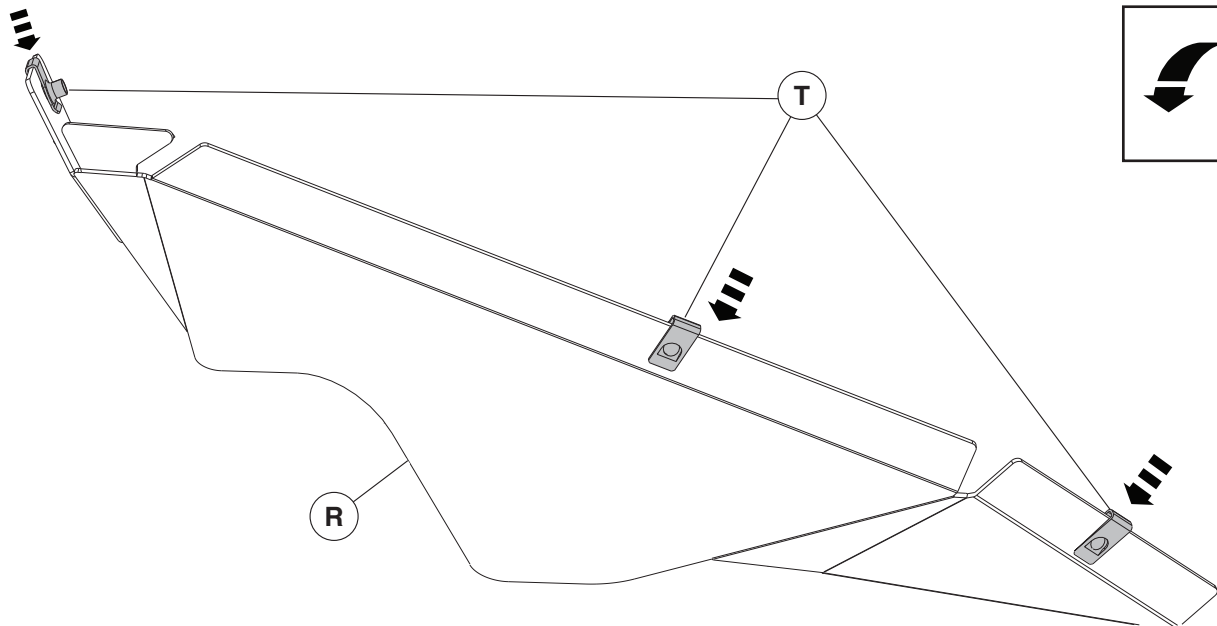

17

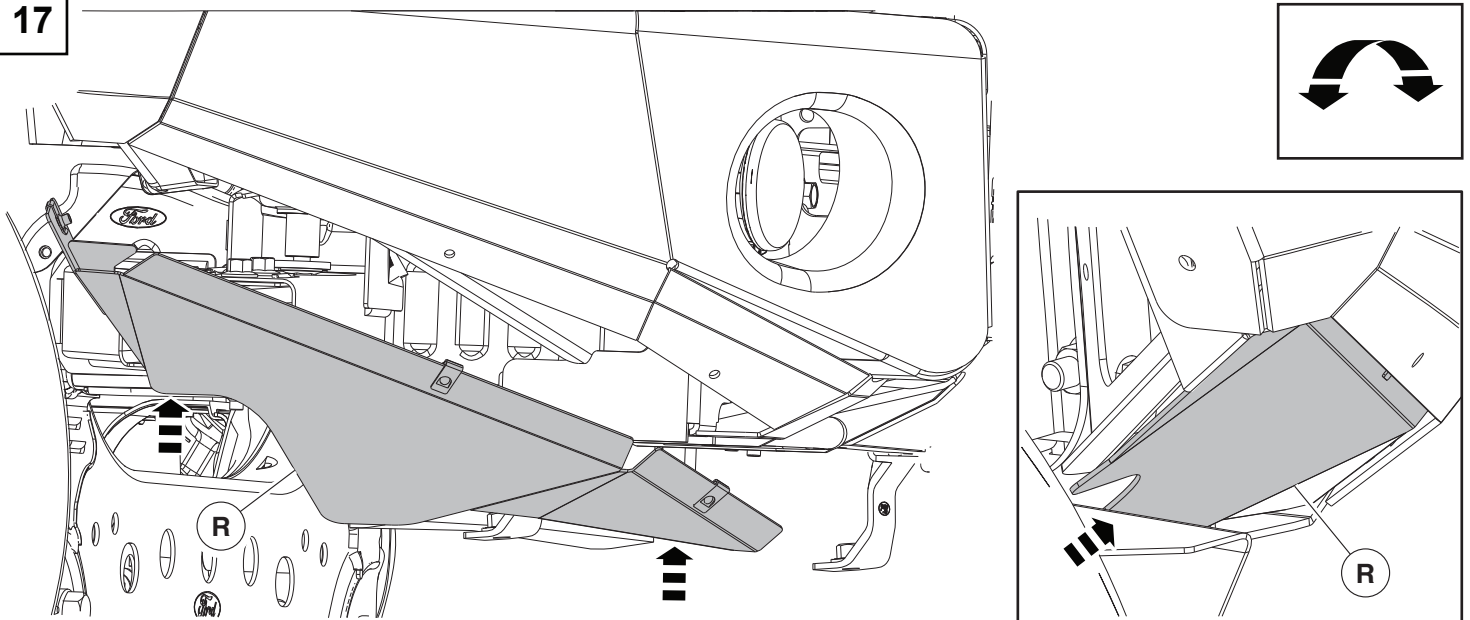

18

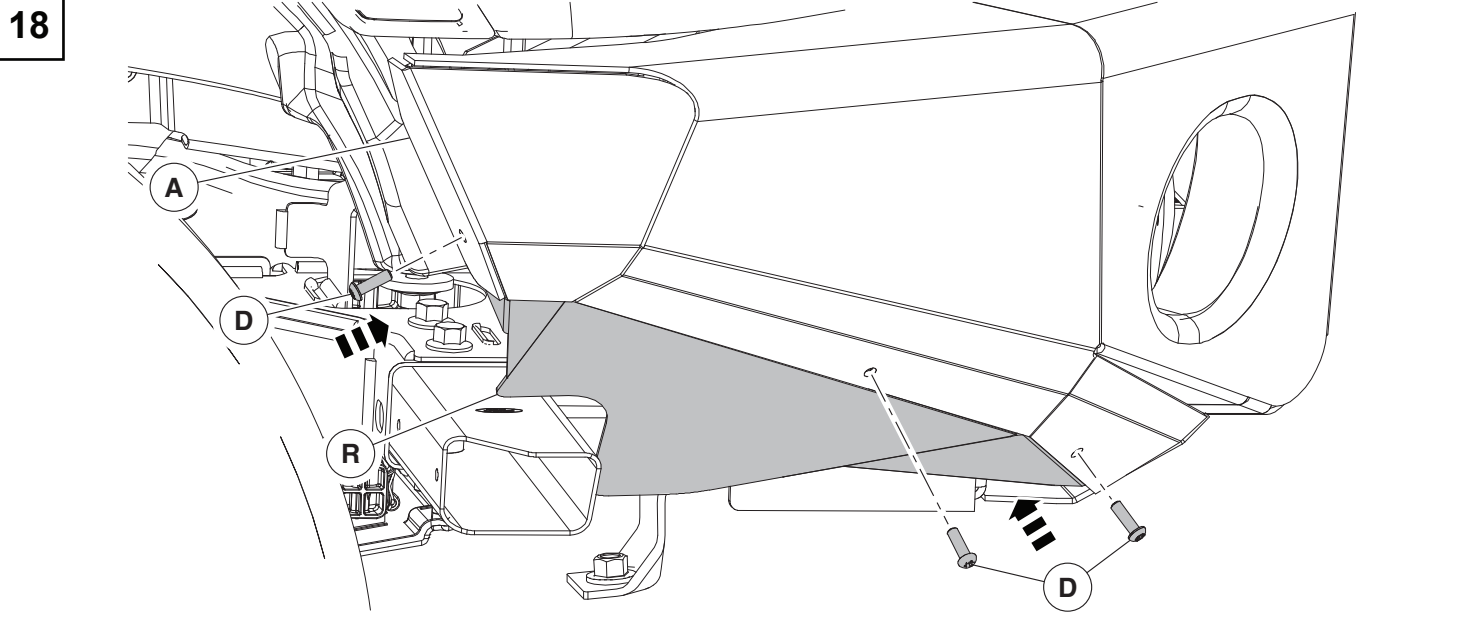

19

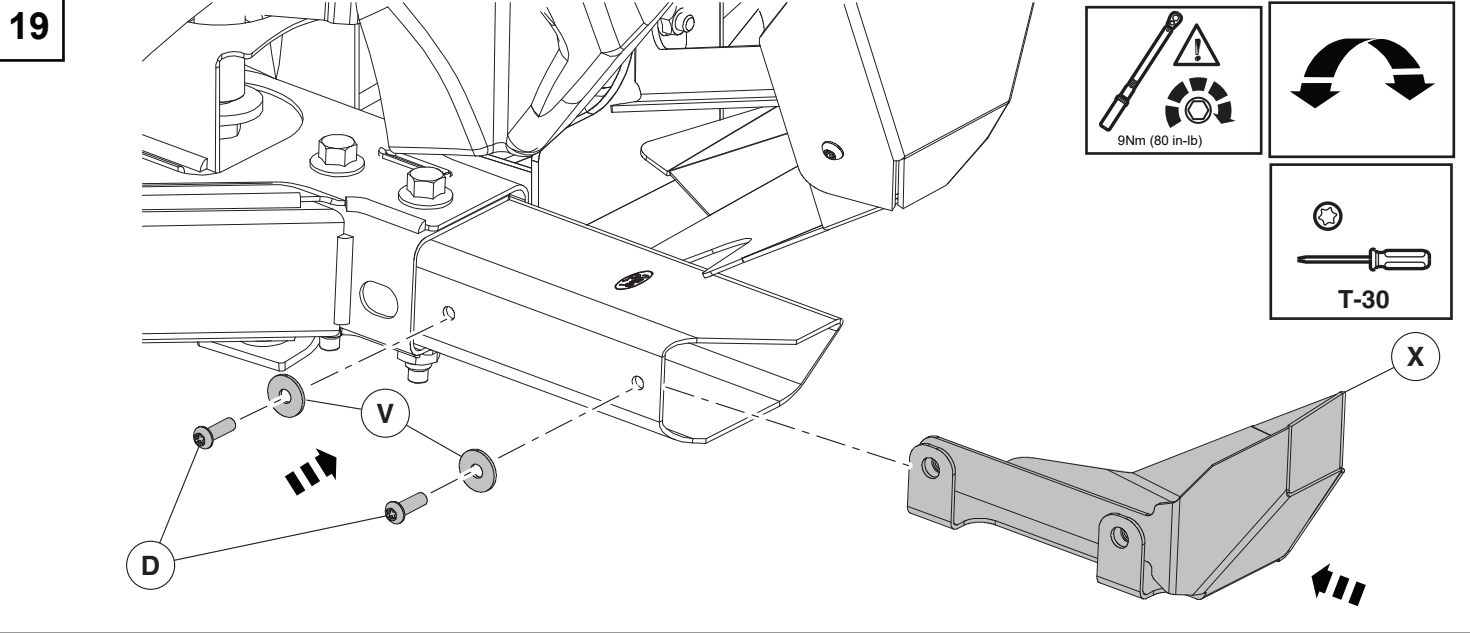

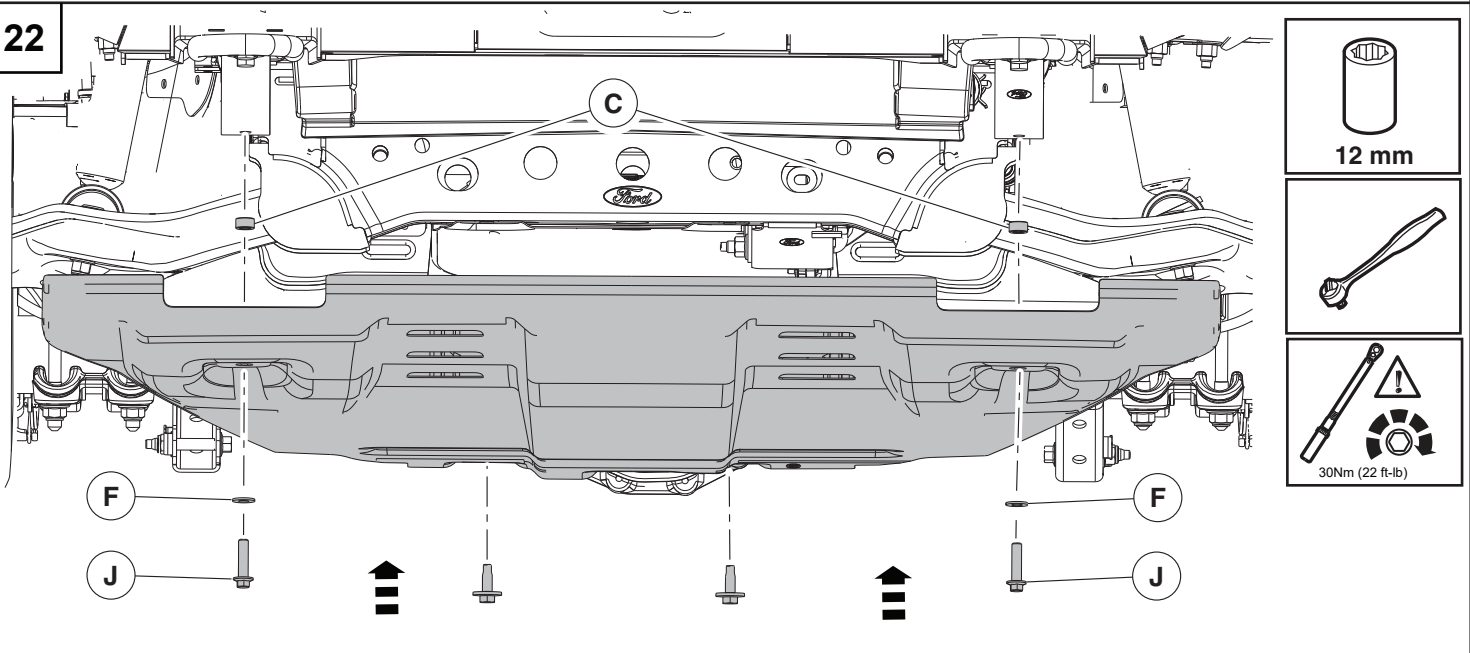
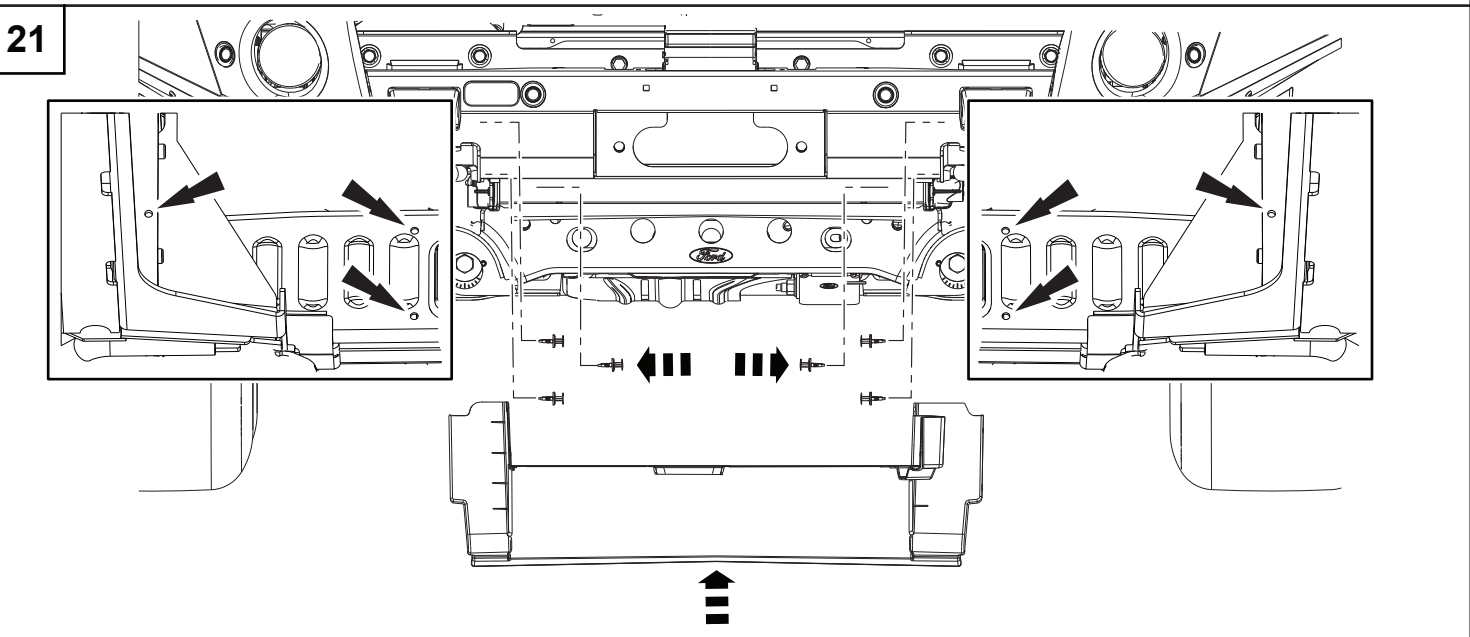
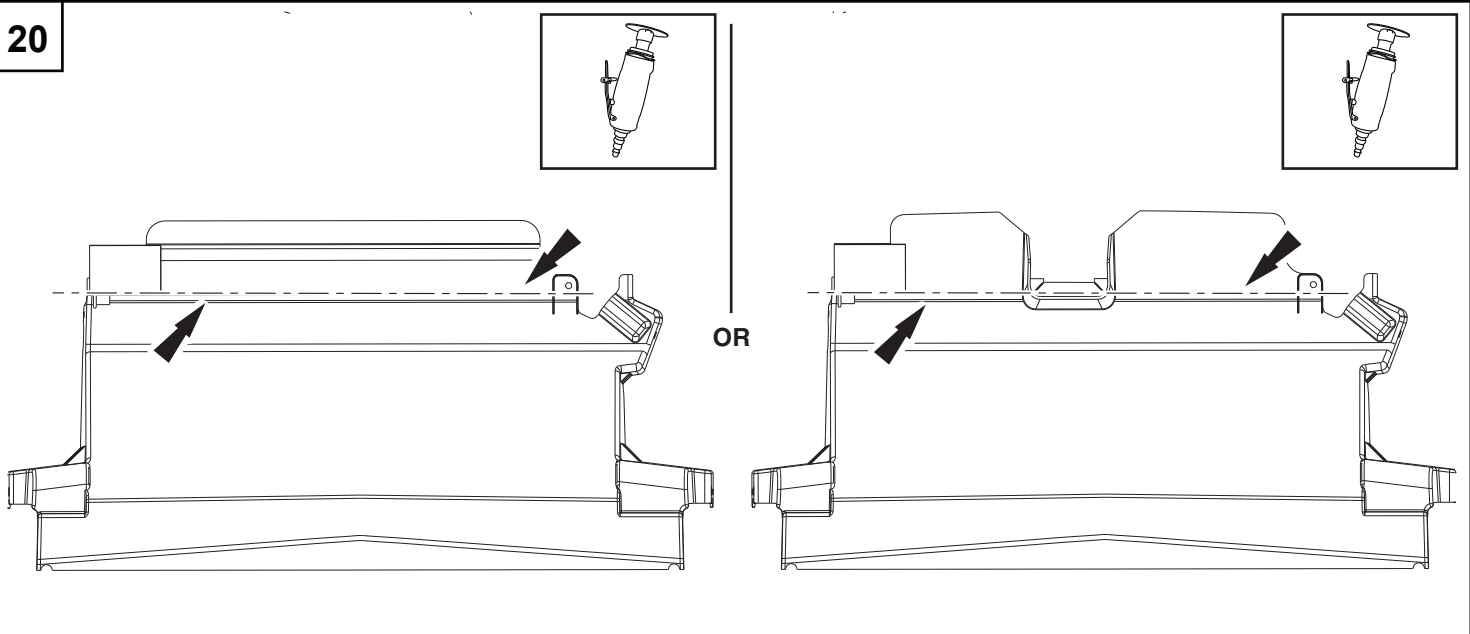

23

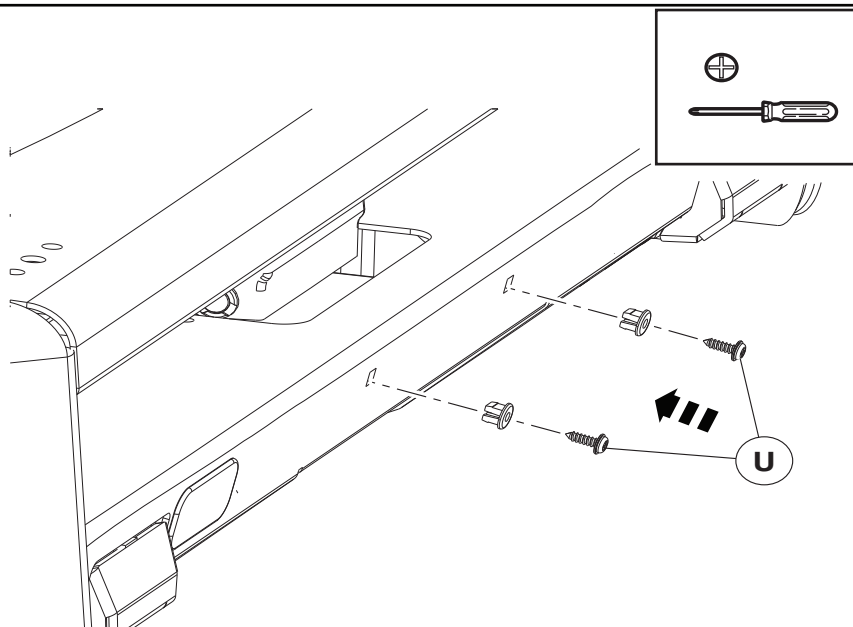

24

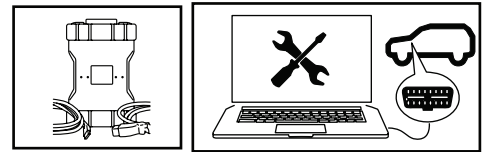

Programming procedure:

1. Connect Ford Diagnostic & Repair System (FDRS) and start a new vehicle session.
2. Select "Toolbox", then scroll down to "BCM - Body Control Module". On the left hand side of the screen download the "BCM - Front Bumper Configuration"
3. Select "Run" after the download has completed. Follow the on-screen instructions to complete the BCM - Front Bumper Configuration.

NOTE: When prompted for part number entry, enter "**M-17757-R1F**". The part numbers are case sensitive. Do Not enter spaces or a part suffix or quotes.

Returning Vehicle to Factory Condition:

After completely removing the Ford Performance Ranger Off-Road Bumper from the vehicle and reinstalling Original Factory Bumper, perform these steps to return the vehicle to factory conditions. A Restraint Control Module (RCM) software update is required after reinstalling Original Factory Bumper to ensure proper airbag deployment and performance of other safety systems.

4. Connect Ford Diagnostic & Repair System (FDRS) and start a new vehicle session.
5. Select "Toolbox", then scroll down to "BCM - Body Control Module". On the left hand side of the screen download the "BCM - Front Bumper Configuration"
6. Select "Run" after the download has completed. Then select "Remove Ford Performance ARB Bumper from Vehicle" and follow the on-screen instructions to complete the BCM - Front Bumper Configuration.

NOTE: During the programming procedure you will be prompted to enter the part number "**RESTORE**". The part numbers are case sensitive and do not include any spaces.